

### Overview

#### HPE Apollo 4200 Gen9 Server

Are you ready to compete in the Big Data arena by making the leap into enterprise-class server storage architecture?

The HPE Apollo 4200 Gen9 Server offers revolutionary storage density in a 2U form factor, with more than double the storage capacity of competitors. If you are running object storage, Hadoop, content delivery, or other data intensive workloads on general purpose servers, the HPE Apollo 4200 Gen9 Server allows you to save valuable data center space through its unique density optimized 2U form factor which holds up to 28 LFF or 54 SFF hot plug drives.



Overview

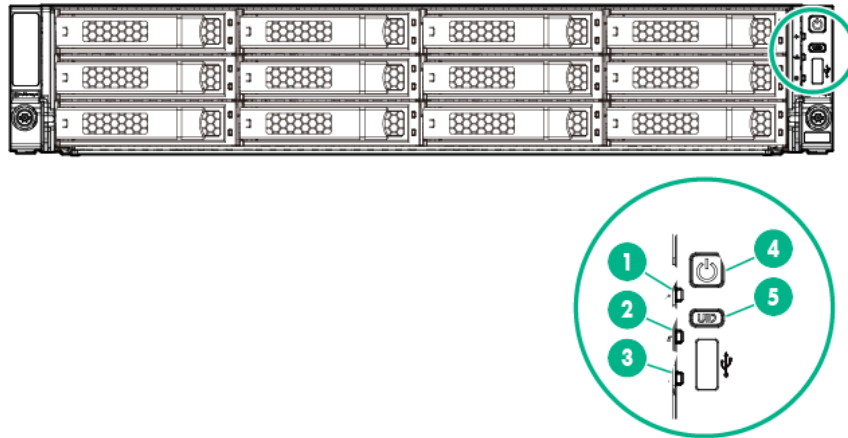

**Item Front panel LEDs and buttons**

- 1 Health LED
- 2 NIC status LED
- 3 Front drive health/thermal LED
- 4 Power On/Standby button and system power LED
- 5 UID button/LED

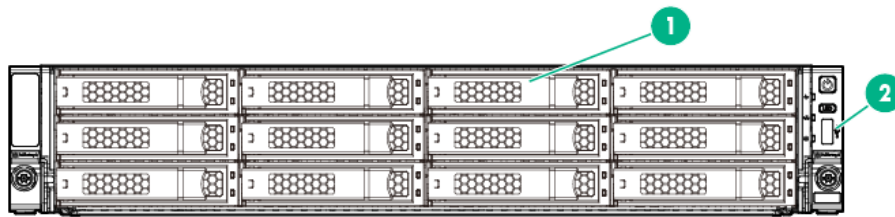

**Item Front View – LFF Chassis**

- 1 LFF hot-plug drives
- 2 USB 2.0 connector

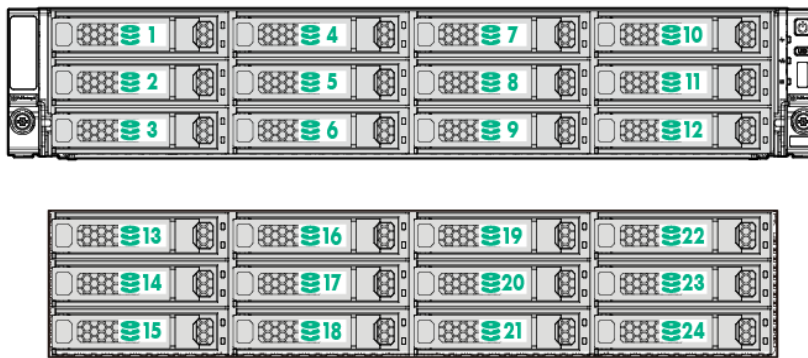

**Item Drive numbering – LFF Chassis**

- 1-12. Front row of LFF drives
- 13-24. Second row of LFF drives

Overview

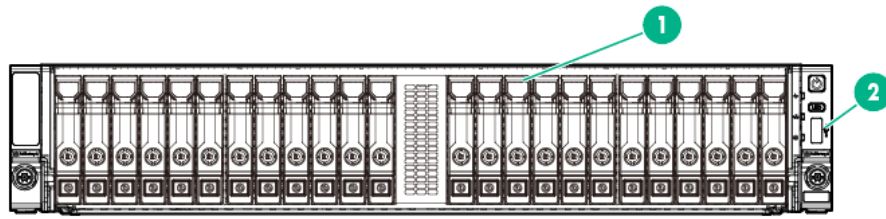

**Item Front View – SFF Chassis**

- 1 SFF hot-plug drives
- 2 USB 2.0 connector

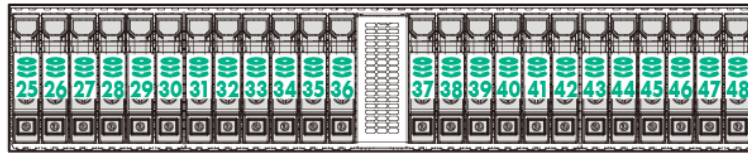
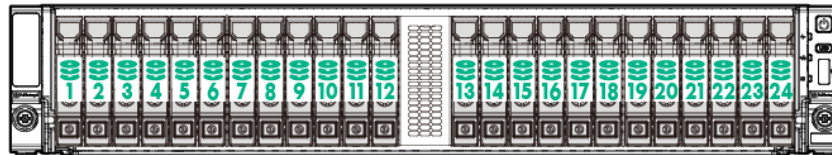

**Item Drive numbering – SFF Chassis**

- 1-24. Front row of SFF drives
- 25-48. Second row of SFF drives

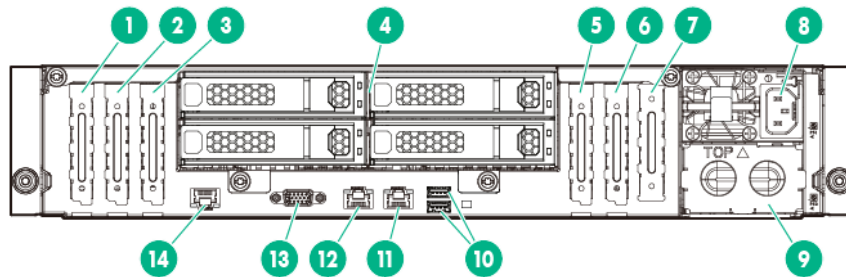

**Rear view with rear LFF Rear HDD cage Kit (LFF Model only)**

- |                                   |   |
|-----------------------------------|---|
| 1. PCIe3 x16 (16, 8, 4, 1) Slot 7 | 8. Hot-plug power supply bay 1                    |
| 2. PCIe3 x8 (8, 4, 1) Slot 6      | 9. Hot-plug power supply bay 2                    |
| 3. PCIe3 x16 (16, 8, 4, 1) Slot 5 | 10. USB 3.0 connectors                            |
| 4. LFF hot-plug drives            | 11. NIC 1/shared iLO connector                    |
| 5. PCIe3 x16 (16, 8, 4, 1) Slot 2 | 12. NIC connector 2                               |
| 6. PCIe3 x8 (8, 4, 1) Slot 1      | 13. Video connector                               |
| 7. FlexibleLOM slot               | 14. Dedicated iLO management connector (optional) |

Overview

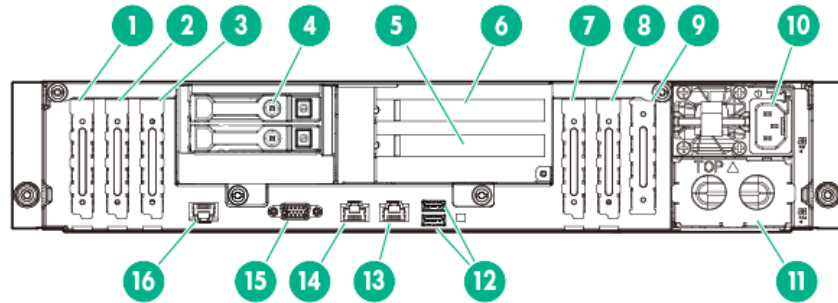

Rear view with 2SFF and 2FHHL Kit

- |  |   |
|--|---|
| 1. PCIe3 x16 (16, 8, 4, 1) Slot 7                                      | 9. FlexibleLOM slot                               |
| 2. PCIe3 x8 (8, 4, 1) Slot 6   | 10. Hot-plug power supply bay 1                   |
| 3. PCIe3 x16 (16, 8, 4, 1) Slot 5                                      | 11. Hot-plug power supply bay 2                   |
| 4. SFF hot-plug drives   | 12. USB 3.0 connectors                            |
| 5. PCIe3 x8 (8, 4, 1) Slot 4   | 13. NIC 1/shared iLO connector                    |
| 6. PCIe3 x8 (8, 4, 1) Slot 3   | 14. NIC connector 2                               |
| 7. PCIe3 Slot 2 for riser cage of slot 3 and slot4 (no slot available) | 15. Video connector                               |
| 8. PCIe3 x8 (8, 4, 1) Slot 1   | 16. Dedicated iLO management connector (optional) |

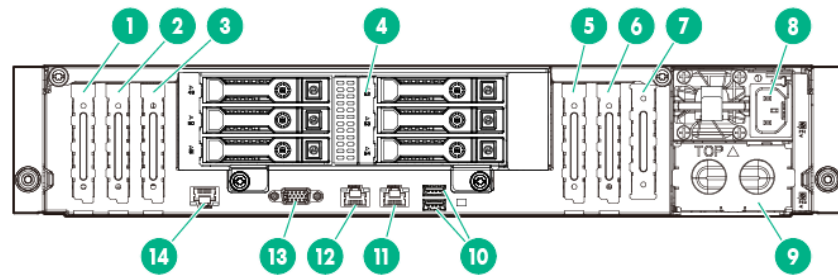

Rear view with 6SFF Rear HDD Cage

- |                                   |   |
|-----------------------------------|---|
| 1. PCIe3 x16 (16, 8, 4, 1) Slot 7 | 8. Hot-plug power supply bay 1                    |
| 2. PCIe3 x8 (8, 4, 1) Slot 6      | 9. Hot-plug power supply bay 2                    |
| 3. PCIe3 x16 (16, 8, 4, 1) Slot 5 | 10. USB 3.0 connectors                            |
| 4. SFF hot-plug drives            | 11. NIC 1/shared iLO connector                    |
| 5. PCIe3 x16 (16, 8, 4, 1) Slot 2 | 12. NIC connector 2                               |
| 6. PCIe3 x8 (8, 4, 1) Slot 1      | 13. Video connector                               |
| 7. FlexibleLOM slot               | 14. Dedicated iLO management connector (optional) |

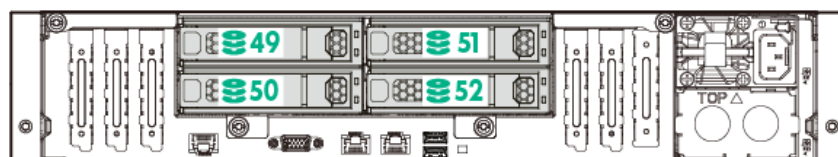

Drive numbering – Four-bay LFF hot-plug rear drive numbering

## Overview

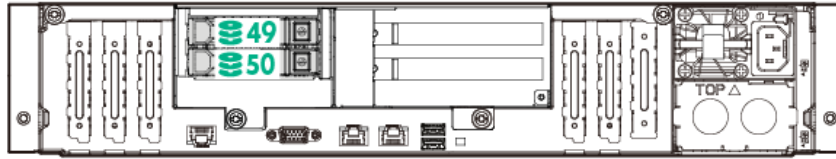

Drive numbering – Two-bay SFF hot-plug rear drive numbering

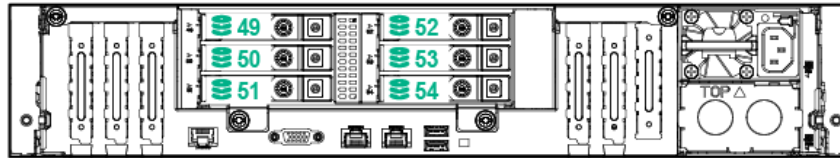

Drive numbering – Six-bay SFF hot-plug rear drive numbering

## Overview

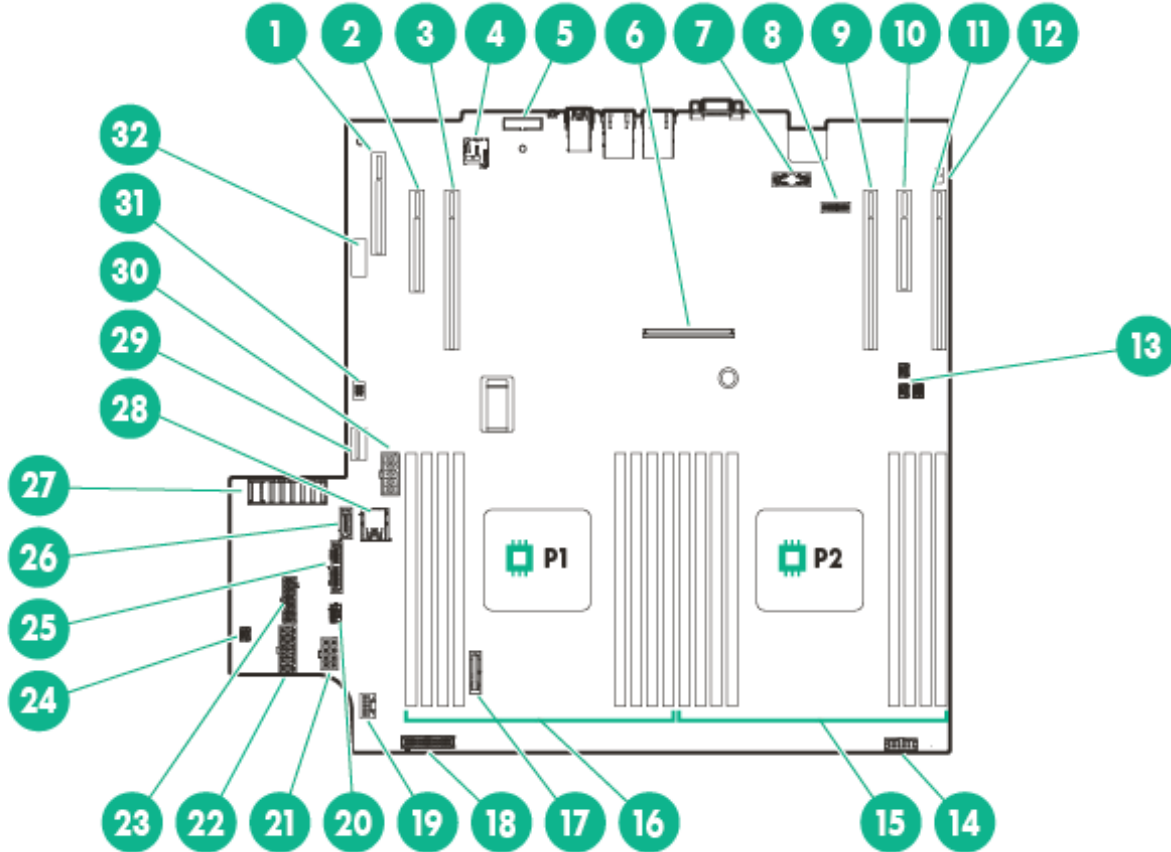

- |  |  |
|--|--|
| 1. FlexibleLOM Slot  | 17. System battery   |
| 2. PCIe3 x8 (8, 4, 1) slot 1 for low-profile, standup expansion board                            | 18. Fan signal connector                                   |
| 3. PCIe3 x16 (16, 8, 4, 1) slot 2 for low-profile, standup expansion board or riser cage options | 19. HPE Smart Storage Battery connector                    |
| 4. microSD slot  | 20. Rear SFF drive backplane detection connector           |
| 5. TPM connector   | 21. Fan power connector                                    |
| 6. HPE Flexible Smart Array Controller slot  | 22. Front drive cage 2 backplane power connector           |
| 7. Dedicated iLO management module connector   | 23. Front drive cage 1 backplane power connector           |
| 8. System maintenance switch   | 24. Storage backup power connector for expansion slots 1–2 |
| 9. PCIe3 x16 (16, 8, 4, 1) slot 5 for low-profile, standup expansion board                       | 25. SATA 6Gb/s connector 4                                 |
| 10. PCIe3 x8 (8, 4, 1) slot 6 for low-profile, standup expansion board                           | 26. SATA 6Gb/s connector 5                                 |
| 11. PCIe3 x16 (16, 8, 4, 1) slot 7 for low-profile, standup expansion board                      | 27. Power pass-through board connector                     |
| 12. NMI header   | 28. Internal USB 3.0 connector                             |
| 13. Storage backup power connectors for expansion slots 3–7                                      | 29. SATA x4 connector 1                                    |
| 14. Front I/O connector  | 30. Rear drive cage backplane power connector              |
| 15. Processor 2 DIMM slots   | 31. Front USB 2.0 connector                                |
| 16. Processor 1 DIMM slots   | 32. 6SFF backplane sideband connector                      |

## Standard Features

**NOTE:** For more information regarding Intel Xeon processors, please see the following <http://www.intel.com/xeon>.

### Processor

Up to two of the following depending on model

Model	CPU frequency	Cores	L3 Cache	Power	QPI	DDR4 Hz
E5-2699v3	2.3GHz	18	45MB	145W	9.6GT/s	2133
E5-2698v3	2.3GHz	16	40MB	135W	9.6GT/s	2133
E5-2697v3	2.6GHz	14	35MB	145W	9.6GT/s	2133
E5-2695v3	2.3GHz	14	35MB	120W	9.6GT/s	2133
E5-2690v3	2.6GHz	12	30MB	135W	9.6GT/s	2133
E5-2683v3	2.0GHz	14	35MB	120W	9.6GT/s	2133
E5-2680v3	2.5GHz	12	30MB	120W	9.6GT/s	2133
E5-2670v3	2.3GHz	12	30MB	120W	9.6GT/s	2133
E5-2667v3	3.2GHz	8	20MB	135W	9.6GT/s	2133
E5-2660v3	2.6GHz	10	25MB	105W	9.6GT/s	2133
E5-2650v3	2.3GHz	10	25MB	105W	9.6GT/s	2133
E5-2650Lv3	1.8GHz	12	30MB	65W	9.6GT/s	2133
E5-2643v3	3.4GHz	6	20MB	135W	9.6GT/s	2133
E5-2640v3	2.6GHz	8	20MB	90W	8.0GT/s	1866
E5-2637v3	3.5GHz	4	15MB	135W	9.6GT/s	2133
E5-2630v3	2.4Ghz	8	20MB	85W	8.0GT/s	1866
E5-2630Lv3	1.8GHz	8	20MB	55W	8.0GT/s	1866
E5-2623v3	3.0GHz	4	10MB	105W	8.0GT/s	1866
E5-2620v3	2.4GHz	6	15MB	85W	8.0GT/s	1866
E5-2609v3	1.9GHz	6	15MB	85W	6.4GT/s	1600
E5-2603v3	1.6GHz	6	15MB	85W	6.4GT/s	1600
E5-2699v4	2.2GHz	22	55MB	145W	9.6GT/s	2400
E5-2698v4	2.2GHz	20	50MB	135W	9.6GT/s	2400
E5-2697v4	2.3GHz	18	45MB	145W	9.6GT/s	2400
E5-2697Av4	2.6GHz	16	40MB	145W	9.6GT/s	2400
E5-2695v4	2.1GHz	18	45MB	120W	9.6GT/s	2400
E5-2690v4	2.6GHz	14	35MB	135W	9.6GT/s	2400
E5-2683v4	2.1GHz	16	40MB	120W	9.6GT/s	2400
E5-2680v4	2.4GHz	14	35MB	120W	9.6GT/s	2400
E5-2667v4	3.2GHz	8	25MB	135W	9.6GT/s	2400
E5-2660v4	2.0GHz	14	35MB	105W	9.6GT/s	2400
E5-2650v4	2.2GHz	12	30MB	105W	9.6GT/s	2400
E5-2650Lv4	1.7GHz	14	35MB	65W	9.6GT/s	2400
E5-2643v4	3.4GHz	6	20MB	135W	9.6GT/s	2400
E5-2640v4	2.4GHz	10	25MB	90W	8.0GT/s	2133
E5-2637v4	3.5GHz	4	15MB	135W	9.6GT/s	2400
E5-2630v4	2.2Ghz	10	25MB	85W	8.0GT/s	2133
E5-2630Lv4	1.8GHz	10	25MB	55W	8.0GT/s	2133
E5-2623v4	2.6GHz	4	10MB	85W	9.6GT/s	2133
E5-2620v4	2.1GHz	8	20MB	85W	8.0GT/s	2133
E5-2609v4	1.7GHz	8	20MB	85W	6.4GT/s	1866

## Standard Features

E5-2603v4	1.7GHz	6	15MB	85W	6.4GT/s	1866
-----------	--------	---	------	-----	---------	------

### Chipset

Intel® C610 Series Chipset  
 Intel® E5-2600v3 Processor Family  
 Intel® E5-2600v4 Processor Family

**NOTE:** For more information regarding Intel chipsets, please see the following URL: <http://www.intel.com/products/server/chipsets/>.

### On System

HPE iLO (Firmware HPE iLO4 2.0) 2GB NAND

### Management Chipset

**NOTE:** Read and learn more in the iLO QuickSpecs.

<http://www8.hp.com/h20195/v2/GetHTML.aspx?docname=c04154343>

### Motherboard

HPE ProLiant XL420 Gen9 Server

**NOTE:** As a reminder that the Apollo 4200 Gen9 Server offers familiar management tools, the motherboard carries a ProLiant name.

**NOTE:** In boot-up, the “HPE ProLiant XL420 Gen9 Server” name will appear.

**NOTE:** The official product name remains HPE Apollo 4200 Gen9 Server, while the motherboard name is “HPE ProLiant XL420 Gen9 Server”

### Memory Protection

Advanced ECC

Advanced ECC uses single device data correction to detect and correct single and all multibit error that occurs within a single DRAM chip.

Online spare

Memory online spare mode detects a rank that is degrading and switches operation to the spare rank.

### Expansion Slots

#### CPU1, (Standard)

Expansion Slots #	Technology	Bus Width	Connector Width	Form Factor	Notes
1	PCIe 3.0	x8	X8	Low profile	Proc 1
2	PCIe 3.0	x16	x16	Low profile	Proc 1

#### Slots with 2 PCIe FHHL riser (CPU1)

Expansion Slots #	Technology	Bus Width	Connector Width	Form Factor	Notes
3	PCIe 3.0	X8	x8	Full-height, half-length slot	Proc 1
4	PCIe 3.0	X8	X8	Full-height, half-length slot	Proc 1

(Optional 2SFF and 2 FHHL Kit: (806564-B21)

**NOTE:** Using optional FHHL kit (PN: 806564-B21), the two PCIe slots (slots 3 and 4) are available by using slot 2 as a standup expansion slot.

**NOTE:** PCIe slots 1-4 are associated with processor 1.

#### CPU 2 (Optional)

Expansion Slots #	Technology	Bus Width	Connector Width	Form Factor	Notes
5	PCIe 3.0	x16	x16	Low Profile	Proc 2
6	PCIe 3.0	x8	x8	Low Profile	Proc 2
7	PCIe 3.0	X16	X16	Low Profile	Proc 2

### Storage Controller

Embedded Controllers

HPE Flexible Smart Array P840ar/2G FIO Controller  
 HPE Dynamic Smart Array B140i Controller

**NOTE:** The P840ar is embedded in the chassis by default, including the HPE Smart Storage Battery.

**NOTE:** The embedded B140i controller will operate in UEFI only mode. For legacy support an additional controller will be needed, and for CTO orders please also select the Legacy mode settings part, 758959-B22.

**NOTE:** The B140i defaults to AHCI off the chipset. Smart Array needs to be enabled on the SATA-only models, if required.

**NOTE:** The B140i will not operate in Legacy mode.



## Standard Features

### Internal Storage

#### Devices

One of the following depending on model

48 SFF plus optional 2 SFF drives rear or 6 SFF drives rear

24 LFF plus optional 4 LFF drives rear, 2 SFF drives rear, or 6 SFF drives rear

**NOTE:** HPE Apollo 4200 Gen9 2SFF and 2FHHL Kit (806564-B21) and HPE Apollo 4200 Gen9 6 SFF Rear Hard Drive Cage Kit (838833-B21) are available for the SFF and LFF models. When using with LFF models, it cannot support HPE 2nd Cage Controller Mode for Rear Storage (813546-B21)

**NOTE:** HPE Apollo 4200 Gen9 LFF Rear HDD Cge Kit (806563-B21) supports an additional 4 LFF drives and is available only for the LFF model.

**CAUTION:** Do not operate the server with any of the rear drive cage bays empty. To maintain proper airflow and sufficient cooling in the rear drive cage, all drive bays in this cage should have a drive or a drive blank. Hewlett Packard Enterprise recommends installing at least one drive in the rear drive cage before operating the Apollo 4200.

SFF Model	CAPACITY	CONFIGURATION
Hot Plug SFF SAS	108TB	48+6 x 2TB (with optional rear SFF drive cage)
Hot Plug SFF SAS SSD	86.4TB	48+6 x 1.6TB (with optional rear SFF drive cage)
Hot Plug SFF SATA	108TB	48+6 x 2TB (with optional SFF drive cage)
Hot Plug SFF SATA SSD	207.36TB	48+6 x 3.84TB (with optional SFF drive cage)
LFF Model	CAPACITY	CONFIGURATION
Hot Plug LFF SAS	224TB	24+4 x 8TB (with optional rear LFF drive cage)
Hot Plug LFF SAS SSD	44.8TB	24+4 x 1.6TB (with optional rear LFF drive cage)
Hot Plug LFF SATA	280TB	24+4 x 8TB (with optional rear LFF drive cage)
Hot Plug LFF SATA SSD	44.8TB	24+4 x 1.6TB (with optional rear LFF drive cage)

### Power Supply

HPE 800W Flex Slot Platinum Hot Plug Power Supply

HPE 1400W Flex Slot Platinum Plus Hot Plug Power Supply

HPE 800W Flex Slot Titanium Hot Plug Power Supply Kit

HPE 800W Flex Slot Universal Hot Plug Power Supply Kit

HPE 800W Flex Slot 48VDC Hot Plug Power Supply Kit

HPE Flexible Slot (Flex Slot) Power Supplies share a common electrical and physical design that allows for hot plug, tool-less installation into HPE ProLiant Gen9 Performance Servers. Flex Slot power supplies are certified for high-efficiency operation and offer multiple power output options, allowing users to "right-size" a power supply for specific server configurations. This flexibility helps to reduce power waste, lower overall energy costs, and avoid "trapped" power capacity in the data center.

All pre-configured servers ship with a standard 6-foot IEC C-13/C-14 jumper cord (AOK02A). This jumper cord is also included with each standard AC power supply option kit. If a different power cord is required, please check the **ProLiant Power Cables** web page.

To review the power requirements for your selected system, please use the HPE Power Advisor Tool located at <http://www.hpe.com/go/hppoweradvisor>

Power specifications and technical content for all HPE Server power supplies can be found at <http://www.hpe.com/go/proliant/powersupply>

### System Fans

#### Non-redundant

#### Redundant

When 1 Processor is selected

4 fans

8 fans

When 2 Processors are selected

5 fans

10 fans

**NOTE:** 1P models typically ship with 4 standard fans. The second processor option kit contains 1 additional fan.

**NOTE:** HPE Apollo 4200 Gen9 Redundant Fan Kit (806562-B21) will ship 5 fans for redundant function

**NOTE:** 1P CTO model with HPE Apollo 4200 Gen9 Redundant Fan Kit (806562-B21) will be shipped with 8 fans installed and 1 spare fan in the carton for the future upgrade to 2 processors.

## Standard Features

<b>Interfaces</b>	Video	1 rear VGA
	FlexibleLOM Network Ports	2 x 1Gb ports shipping standard with optional FlexibleLOM
	HPE iLO Remote Management Network Port	Shared (Optional 1 Gb HPE Apollo 4200 Gen9 Dedicated iLO Management Port Kit 806565-B21)
	Micro SD Slot	1 Micro SD
	USB 2.0	1 front
	USB 3.0	2 rear, 1 internal

### Operating Systems and Virtualization

Software Support for ProLiant Servers

#### **Microsoft Windows Server**

#### **Canonical Ubuntu**

#### **Red Hat Enterprise Linux (RHEL)**

#### **SUSE Linux Enterprise Server (SLES)**

#### **VMware**

**NOTE:** For more information on the HPE Certified and Supported ProLiant Servers for OS and Virtualization Software and latest listing of software drivers available for your server, please visit our Support Matrix at: <http://www.hpe.com/go/ossupport> and our driver download page: <http://h20566.www2.hpe.com/portal/>

### Upgradeability

Upgradeable to two processors (44 Cores)

**NOTE:** Processor upgrade available from Intel® Xeon® Processors E5-2600v3 or E5-2600v4. Please contact Hewlett Packard Enterprise Technology Sales <https://www.hpe.com/support>, your local Hewlett Packard Enterprise Re-seller.

- Up to 16 DIMM slots available for higher Memory capacity
- FlexibleLOM connector for 1 Gigabit or 10 Gigabit networking options
- HPE Flexible Smart Array or Smart HBA Controllers
- Embedded rear 6-Port SATA, B140i as standard
- Optional 2 PCIe slot riser (x8, x8)

**NOTE:** To utilize PCIe slots 3 and 4, riser kit must be purchased

**NOTE:** To take advantage of the additional 3 PCIe slot upgrade, the second processor must be installed.

- Optional 4LFF kit in rear, 2SFF+2FHHL PCIe kit, or 6SFF kit
- Redundant Power Supply
- HPE Legacy Mode (FIO only, 758959-B22)

**NOTE:** UEFI is the default mode for CTO and pre-configured SKUs. Can change default to legacy via CTO.

### Industry Standard Compliance

ACPI 2.0b Compliant  
 PCIe 3.0 Compliant  
 PXE Support  
 WOL Support  
 Microsoft® Logo certifications  
 USB 3.0 Support  
 USB 2.0 Support  
 ASHRAE A3

**NOTE:** For additional technical thermal details regarding ambient temperatures, humidity and features support please visit: <http://www.hp.com/servers/ASHRAE>

UEFI (Unified Extensible Firmware Interface Forum)

**NOTE:** UEFI is the default for the HPE Apollo 4200 Gen9. Legacy model can be selected in the field or as a CTO option (758959-B22).

## Standard Features

<b>Graphics</b>	<p>Integrated Matrox G200eH2 video standard with 16MB of Video RAM</p> <ul style="list-style-type: none"> <li>• 1280 x 1024 (32 bpp)</li> <li>• 1920 x 1200 (16 bpp)</li> </ul> <p>HPE iLO 4 On System Management Memory</p> <ul style="list-style-type: none"> <li>• 16 MB Flash</li> <li>• 128 MB DDR3</li> </ul>
<b>HPE Server UEFI/Legacy ROM</b>	<p><b>HPE Server UEFI /Legacy ROM</b></p> <p>Unified Extensible Firmware Interface (UEFI) is an industry standard that provides better manageability and more secured configuration while interacting with your server at boot time. HPE Gen9 platform defaults to UEFI and can be field configured for Legacy BIOS Boot Mode.</p> <p><b>NOTE:</b> The UEFI System Utilities function is analogous to the HPE ROM-Based Setup Utility (RBSU) of legacy BIOS. For more information, please visit <a href="http://www.hpe.com/go/proliantuefi/docs">http://www.hpe.com/go/proliantuefi/docs</a></p> <p>UEFI enables numerous new capabilities specific to Hewlett Packard Enterprise servers such as:</p> <ul style="list-style-type: none"> <li>• Secure Boot</li> <li>• Operating system specific functionality</li> <li>• Support for &gt; 2.2 TB (using GPT) boot drives</li> <li>• USB 3.0 Stack</li> <li>• Embedded UEFI Shell</li> <li>• Mass Configuration Deployment Tool using HPE RESTful API.</li> <li>• PXE boot support for IPv6 networks</li> <li>• Boot support for option cards that only support a UEFI option ROM</li> </ul> <p><b>For more information please visit <a href="http://www.hpe.com/go/proliant/uefi">http://www.hpe.com/go/proliant/uefi</a></b></p> <p><b>NOTE:</b> For UEFI Boot Mode, boot environment and OS image installations should be configured properly to support UEFI.</p> <p><b>NOTE:</b> HPE Legacy FIO Mode Setting (758959-B22) can be selected to configure the system in Legacy mode in the factory.</p>
<b>Form Factor</b>	<p>2U Rack form factor</p> <p>LFF and SFF Drive Bay Versions:</p> <p>3.44 in x 17.63 in x 32 in (8.75cm x 44.8 cm x 81.28 cm)</p> <p><b>NOTE:</b> Dimensions without bezel.</p>
<b>Embedded Management</b>	<p><b>HPE Integrated Lights-Out (HPE iLO)</b> Monitor your servers for ongoing management, service alerting, reporting and remote management with HPE iLO. Learn more at <a href="http://www.hp.com/go/ilo">http://www.hp.com/go/ilo</a>.</p> <p><b>UEFI</b> Configure and boot your servers securely with industry standard Unified Extensible Firmware Interface (UEFI). Learn more at <a href="http://www.hpe.com/go/proliant/uefi">http://www.hpe.com/go/proliant/uefi</a></p> <p><b>RESTful API</b> A single programmatic web interface that allows you to manage and monitor your server infrastructure using basic HTTP operations (GET, PUT, POST, DELETE and PATCH). RESTful API for iLO 4 conforms to the Redfish 1.0 DMTF standard (iLO firmware version v2.30 or higher required for Redfish conformance). For more details visit: <a href="http://www.hp.com/go/restfulapi">http://www.hp.com/go/restfulapi</a>.</p> <p><b>Intelligent Provisioning</b> Provision servers by discovering and deploying 1 to few servers with Intelligent Provisioning. Learn more at <a href="http://www.hp.com/go/intelligentprovisioning">http://www.hp.com/go/intelligentprovisioning</a>.</p> <p><b>Embedded Remote Support</b> Hewlett Packard Enterprise embedded remote support, used with Insight Online direct connect or HPE Insight Remote Support, allows HPE ProLiant servers to transmit hardware events directly to Hewlett Packard Enterprise or a Hewlett Packard Enterprise Authorized Partner for automated phone home support. Learn more at <a href="http://www.hp.com/go/insightonline/info">http://www.hp.com/go/insightonline/info</a>.</p>

## Standard Features

<b>Server Utilities</b>	<b>Smart Update</b>	Optimize firmware and driver updates with Smart Update solutions including Smart Update Manager (SUM) and Service Pack for ProLiant (SPP). Learn more at <a href="http://www.hp.com/go/smartupdate">http://www.hp.com/go/smartupdate</a> .
	<b>HPE Systems Insight Manager (HPE SIM)</b>	HPE SIM allows you to monitor the health of your HPE ProLiant Servers and HPE Integrity Servers, and also provides you with basic support for non-Hewlett Packard Enterprise servers. HPE SIM also integrates with SUM to provide quick and seamless firmware updates. Learn more at <a href="http://www.hp.com/go/sim">http://www.hp.com/go/sim</a> .
	<b>Scripting Tool Kit and Windows PowerShell</b>	Provision 1 to many servers using your own scripts to discover and deploy them with Scripting Tool Kit for Windows and Linux or Scripting Tools for Windows PowerShell. Learn more at <a href="http://www.hp.com/go/ProLiantSTK">http://www.hp.com/go/ProLiantSTK</a> or <a href="http://www.hp.com/go/powershell">http://www.hp.com/go/powershell</a> .
	<b>RESTful Interface Tool</b>	Scripting tool to provision servers using iLO 4 RESTful API to discover and deploy servers at scale. Learn more at <a href="http://www.hp.com/go/resttool">http://www.hp.com/go/resttool</a>
	<b>HPE iLO Mobile Application</b>	Enables the ability to access, deploy, and manage your server anytime from anywhere from select smartphones and mobile devices. For additional information please visit: <a href="http://www.hp.com/go/ilo/mobileapp">http://www.hp.com/go/ilo/mobileapp</a> .
	<b>HPE Insight Online</b>	HPE Insight Online, available at no additional cost as part of your Hewlett Packard Enterprise warranty, Care Pack or contractual support agreement with Hewlett Packard Enterprise, is a personalized dashboard for simplified tracking of IT operations and support information from anywhere, anytime. Learn more at <a href="http://www.hp.com/go/insightonline/info">http://www.hp.com/go/insightonline/info</a> .
<b>Security</b>		<ul style="list-style-type: none"> <li>Power-on password</li> <li>Serial interface control</li> <li>Administrator's password</li> <li>UEFI</li> <li>iLO 4 (Integrated Lights-Out 4) has 12 customizable user accounts and SSL encryption</li> <li>Integrated Lights-Out can be disabled via a Global Setting</li> <li>iLO Advanced supports directory services integration</li> <li>TPM 1.2 or 2.0</li> </ul>
<b>Warranty</b>		<p>This product is covered by a global limited warranty and supported by Hewlett Packard Enterprise Enterprise Services and a worldwide network of Hewlett Packard Enterprise Enterprise Authorized Channel Partners resellers. Hardware diagnostic support and repair is available for three years from date of purchase. Support for software and initial setup is available for 90 days from date of purchase. Enhancements to warranty services are available through HPE Pointnext operational services or customized service agreements. Hard drives have either a one year or three year warranty; refer to the specific hard drive QuickSpecs for details.</p> <p><b>NOTE:</b> Server Warranty includes 3-Year Parts, 1-Year Labor, 1-Year Onsite support with next business day response. Warranty repairs may be accomplished through the use of Customer Self Repair (CSR) parts. These parts fall into two categories: 1) Mandatory CSR parts are designed for easy replacement. A travel and labor charge will result when customers decline to replace a Mandatory CSR part; 2) Optional CSR parts are also designed for easy replacement but may involve added complexity. Customers may choose to have Hewlett Packard Enterprise Enterprise replace Optional CSR parts at no charge. Additional information regarding worldwide limited warranty and technical support is available at: <a href="http://h18004.www1.hp.com/products/servers/platforms/warranty/index.html">http://h18004.www1.hp.com/products/servers/platforms/warranty/index.html</a></p>

## Optional Features

<b>Embedded Management</b>	<b>iLO Advanced</b>	HPE iLO Advanced licenses offer smart remote functionality without compromise, for all HPE ProLiant servers. The license includes the full integrated remote console, virtual keyboard, video, and mouse (KVM), multi-user collaboration, console record and replay, and GUI-based and scripted virtual media and virtual folders. You can also activate the enhanced security and power management functionality. Learn more about HPE iLO Advanced at <a href="http://www.hpe.com/go/iloadvanced">http://www.hpe.com/go/iloadvanced</a>
<b>Server Management</b>	<b>HPE Insight Control</b>	HPE Insight Control, lets you deploy, migrate, monitor, remote control, and optimize your IT infrastructure through a single, simple management console. For more information, see <a href="http://www.hp.com/go/insightcontrol">http://www.hp.com/go/insightcontrol</a>
	<b>HPE Insight Cluster Management Utility (CMU)</b>	HPE Insight Cluster Management Utility is a hyperscale-optimized management framework that includes software for the provisioning, control, performance management and monitoring of groups of nodes and infrastructure. Learn more at <a href="http://www.hpe.com/go/cmu">http://www.hpe.com/go/cmu</a>
<b>Rack and Power Infrastructure</b>	HPE Rack and Power Infrastructure products and services create highly efficient and intelligent solutions for existing or new IT data centers. HPE Rack and Power infrastructure solutions – rack infrastructure, power protection and management, performance optimized data centers (PODs) – are the foundation you are looking for to help secure your long-term IT success. These products are designed to help you react to changes in the industry. They deliver efficient, easy-to-use capabilities to manage, monitor, deploy and provision infrastructure from entry to enterprise. As an industry leader, Hewlett Packard Enterprise Enterprise is uniquely positioned to address the key concerns of power, cooling, cable management and system access. Learn more at <a href="#">HPE Rack and Power Infrastructure</a>	
<b>High Performance Clusters</b>	HPE Cluster Platforms are specifically engineered, factory-integrated large-scale ProLiant clusters optimized for High Performance Computing, with a choice of servers, networks and software. Operating system options include specially priced offerings for Red Hat Enterprise Linux and SUSE Linux Enterprise Server, as well as Microsoft Windows HPC Server. A Cluster Platform Configurator simplifies ordering. <a href="http://www.hpe.com/go/clusters">http://www.hpe.com/go/clusters</a> <b>NOTE:</b> High Performance Computing (HPC) interconnect technologies are available for this server as part of the HPE Cluster Platform portfolio. These high-speed InfiniBand and Gigabit interconnects are fully supported by Hewlett Packard Enterprise when integrated within an HPE cluster. Flexible, validated solutions can be defined with the help of configuration tools. <a href="http://www.hpe.com/techservers/clusters/ucp/index.html">http://www.hpe.com/techservers/clusters/ucp/index.html</a>	
<b>HPC Interconnects</b>	<b>NOTE:</b> High Performance Computing (HPC) interconnect technologies are available for this server under the HPE Cluster Platform product portfolio. These high-speed interconnects are fully supported by Hewlett Packard Enterprise when they are part of these configure to order clusters. Solutions can be defined with a lot of flexibility with the help of configuration tools. Please visit the following URL to configure HPC Clusters with InfiniBand Interconnects: <a href="http://www.hpe.com/techservers/clusters/ucp/index.html">http://www.hpe.com/techservers/clusters/ucp/index.html</a>	
<b>Storage Software</b>	Whether you need to solve a specific data protection, archiving, or storage command and control challenge, or deliver on strategic consolidation, compliance, or continuity initiatives, look no further than HPE storage software. Our storage software helps you reduce costs, simplify storage infrastructure, protect vital assets and respond faster to business opportunities. Storage software that gets the job done: <ul style="list-style-type: none"> <li>• <b>Data Protection and Recovery Software</b> Whether you're a large enterprise or a smaller business, Hewlett Packard Enterprise data protection and recovery software will cost-effectively protect you against disaster and ensure business continuity.</li> </ul>	

## Optional Features

- **Data Archive and Migration Software**  
The HPE storage software enables you to comply with data retention and retrieval requirements, improve application performance, and reduce costs by efficiently migrating infrequently accessed or less valuable data to lower cost storage.
- **Storage Resource Management Software (SRM)**  
The HPE storage resource management software reduces operational costs and provides the command and control foundation you need to efficiently manage and visualize your physical and virtual environments.
- **Data Replication Software**  
Hewlett Packard Enterprise offers array-based and host-based replication software for use in disaster recovery, testing, application development and reporting.
- **Storage Device Management Software**  
Maximize your investment in HPE storage and networking with software that enables hardware-specific configuration, performance tuning and connectivity management.
- **HPE StoreVirtual VSA**  
With HPE StoreVirtual VSA you can use the power of virtualization to create a virtual array within your host server. Manage it as a single pool of shared storage capacity, and scale it to match your evolving needs. HPE ProLiant Gen9 servers include a 3-year limited license for HPE StoreVirtual VSA software with 1TB of capacity at no extra cost. Simply select to install HPE StoreVirtual VSA software during server setup within Intelligent Provisioning. More information, instructional videos, and free console management software are available at <http://www.hpe.com/go/vsa1TB>

**NOTE:** For more information about Storage Software including QuickSpecs, please see: <http://www.hpe.com/go/storage/software>

### One Config Simple (SCE)

SCE is a guided self-service tool to help sales and non-technical people provide customers with initial configurations in 3 to 5 minutes. You may then send the configuration on for configuration help, or use in your existing ordering processes. If you require "custom" rack configuration or configuration for products not available in SCE, please contact the HPE Customer Business Center or an Authorized Partner for assistance.

<http://www.hpe.com/products/configurator>

## Service and Support

### Service and Support **HPE Technology Services for Industry Standard Servers**

HPE Technology Services delivers confidence, reduces risk and helps customers realize agility and stability. Connect to Hewlett Packard Enterprise to help prevent problems and solve issues faster. Our support technology lets you to tap into the knowledge of millions of devices and thousands of experts to stay informed and in control, anywhere, any time.

### **Protect your business beyond warranty with HPE Pointnext operational services**

HPE Pointnext operational services enable you to order the right service level, length of coverage and response time as you purchase your new server, giving you full entitlement for the selected support.

### Optimized Care **Supports maintaining servers at optimum performance availability**

#### **HPE Proactive Care with 24x7 coverage, three year Care Pack Service**

HPE Proactive Care helps prevent problems and stabilize IT by utilizing secure, real-time, predictive analytics and proactive consultations when your products are connected to Hewlett Packard Enterprise. This Care Pack Service combines three years' proactive reporting and advice with our 24x7 coverage and enhanced escalation management, four hour hardware response time and two hour call back for software questions on leading industry standard software running on your HPE ProLiant

server. <https://www.hpe.com/h20195/v2/GetPDF.aspx/4AA3-8855ENW.pdf>

### Standard Care Package **Supports maintaining high level of server availability**

#### **HPE Proactive Care with 6 hour call-to-repair commitment, three year Care Pack Service**

HPE Proactive Care helps prevent problems and maintains IT stability by utilizing personalized proactive reports with recommendations and advice when your products are connected to Hewlett Packard Enterprise. This Service combines three years' proactive reporting and advice with our highest level reactive coverage - Hewlett Packard Enterprise 24x7, six hour hardware call-to-repair. Hewlett Packard Enterprise is the only leading manufacturer who makes this level of coverage available as a standard service offering for your most valuable servers. Service includes collaborative software support for Independent Software Vendors software (Red Hat, VMWare, Microsoft, etc.) running on your HPE ProLiant/Apollo server.

<https://www.hpe.com/h20195/v2/GetPDF.aspx/4AA3-8855ENW.pdf>

### Related Services **HPE Server Hardware Installation**

Provides for the basic hardware installation of Hewlett Packard Enterprise branded servers, storage devices and networking options to assist you in bringing your new hardware into operation in a timely and professional manner.

<https://www.hpe.com/h20195/V2/GetPDF.aspx/5981-9356EN.pdf>

**Data Privacy** – protect your data through better media management. Hewlett Packard Enterprise data privacy services help manage and protect sensitive data to reduce the risk of unauthorized access to private information and help meet compliance requirements. Our retention services allow you to keep drives and other devices upon failure, our removal services provide convenient data sanitization and our recovery services allow you to safely retire IT assets and capture any remaining value from the hardware. <http://www.hp.com/services/dataprivacy>

### **Factory Express for Servers and storage**

HPE Factory Express offers configuration, customization, integration and deployment services for Hewlett Packard Enterprise servers and storage products. Customers can choose how their factory solutions are built, tested, integrated, shipped and deployed.

Factory Express offers service packages for simple configuration, racking, installation, complex configuration and design services as well as individual factory services, such as image loading, asset tagging, and custom packaging. Hewlett Packard Enterprise products supported through Factory Express include a wide array of servers and storage: HPE Integrity, HPE ProLiant, HPE Apollo, HPE ProLiant Server Blades, HPE BladeSystem,

## Service and Support

HPE 9000 servers as well as the MSAxxxx3PAR suite, XP, rackable tape libraries and configurable network switches.

For more information on Factory Express services for your specific server model please contact your sales representative or go to: <http://www.hp.com/go/factory-express>.

**Additional HPE Pointnext operational services can be found at:** <http://www.hp.com/go/cpc>

- Connect your devices to Hewlett Packard Enterprise** Unlock all of the benefits of your technology investment by connecting your products to Hewlett Packard Enterprise. Achieve up to 77% reduction in down time, near 100% diagnostic accuracy and a single consolidated view of your environment. By connecting, you will receive 24x7 monitoring, pre-failure alerts, automatic call logging, and automatic parts dispatch. HPE Proactive Care Service and HPE Datacenter Care Service customers will also benefit from proactive activities to help prevent issues and increase optimization. All of these benefits are already available to you with your server storage and networking products, securely connected to Hewlett Packard Enterprise support.
- HPE Support Center** Personalized online support portal with access to information, tools and experts to support Hewlett Packard Enterprise business products. Submit support cases online, chat with Hewlett Packard Enterprise experts, access support resources or collaborate with peers. Learn more <http://www.hp.com/go/hpsc>
- HPE Support Center Mobile App\*\* allows you to resolve issues yourself or quickly connect to an agent for live support. Now, you can get access to personalized IT support anywhere, anytime.
- HPE Insight Remote Support and HPE Support Center are available at no additional cost with a Hewlett Packard Enterprise warranty, Care Pack or Hewlett Packard Enterprise contractual support agreement.
- \*\* HPE Support Center Mobile App is subject to local availability
- Parts and Materials** Hewlett Packard Enterprise will provide HPE-supported replacement parts and materials necessary to maintain the covered hardware product in operating condition, including parts and materials for available and recommended engineering improvements.
- Parts and components that have reached their maximum supported lifetime and/or the maximum usage limitations as set forth in the manufacturer's operating manual, product quick-specs, or the technical product data sheet will not be provided, repaired, or replaced as part of these services.
- The defective media retention service feature option applies only to Disk or eligible SSD/Flash Drives replaced by Hewlett Packard Enterprise due to malfunction.
- For more information** To learn more on HPE ProLiant servers, please contact your Hewlett Packard Enterprise sales representative or Hewlett Packard Enterprise Authorized Channel Partner or visit: <http://www.hp.com/services/proliant>



## Pre-configured Models

**NOTE:NOTE:** For the Standard Features shipped in the "Factory Integrated Models", please see the "Configuration Information - Factory Integrated Models" section.

Pre-configured models ship with the configurations below. Options can be selected from the Core or Additional options section of this QuickSpecs.

Hewlett Packard Enterprise does not allow factory integration of options into pre-configured models. Any additional options purchased will be shipped separately.

If you desire a custom configuration please see "Configuration Information - Factory Integrated Models" section of this QuickSpecs. **NOTE:NOTE:** All Pre-configured Models come populated with some hard drive blanks installed. Should the customer need additional hard drive blanks, they can order more using either P/N 666987-B21: HPE SFF Hard Drive Blank Kit or P/N 807878-B21: HPE LFF Hard Drive Blank Kit.

**NOTE:NOTE:** All pre-configured servers ship with a standard 6-foot IEC C-13/C-14 jumper cord (A0K02A). This jumper cord is also included with each standard AC power supply option kit. If a different power cord is required, please check the ProLiant Power Cables web page.

**CAUTION:CAUTION:** Hewlett Packard Enterprise recommends that a minimum of two people are required for all Rack Server installations. Please refer to your installation instructions for proper tools and number of people to use for any installation.

### E5-2600v3 Series Pre-configured Models

#### [SKU Number]

806357-B21

806356-B21

#### Model Name

HPE Apollo 4200 Gen9 E5-2620v3 SFF Server

HPE Apollo 4200 Gen9 E5-2620v3 LFF Server

#### Processor

Intel® Xeon® E5-2620v3

Intel® Xeon® E5-2620v3

#### Number of Processors

One

#### Memory

16GB (1x16GB Registered DIMMs, 2133 MHz)

**NOTE:NOTE:** with the E5-2620v3 this memory DIMM will only operate at 1866MHz

16GB (1x16GB Registered DIMMs, 2133 MHz)

**NOTE:NOTE:** with the E5-2620v3 this memory DIMM will only operate at 1866MHz

#### Network Controller

HPE Embedded 1Gb Ethernet 2-port 361i Adapter

#### Storage Controller

HPE Flexible Smart Array P840ar/2G Controller

HPE Flexible Smart Array P840ar/2G Controller

#### Hard Drive

None ship standard

22SFF hard drive blanks

## Pre-configured Models

### None ship standard

10 LFF hard drive blanks

### Internal Storage

48 SFF HDD Bays and optional 2SFF Rear Cage Kit or 6SFF Rear Cage Kit

28 LFF HDD Bays and optional 4LFF Rear Cage Kit, 2SFF Rear Cage Kit, or 6SFF Rear Cage Kit

### PCI-Express Slots

2 PCIe slots and FlexibleLOM (+3 PCIe slots available with upgrade to second processor and optional 2 FHHL slots available with purchase of 2SFF and 2FHHL Rear Cage Kit)

2 PCIe slots and FlexibleLOM (+3 PCIe slots available with upgrade to second processor)

### Power Supply

(1) HPE 1400W Flex Slot Platinum Power Supply

(1) HPE 1400W Flex Slot Platinum Power Supply

### Fans

4 fans

4 fans

### Management

iLO Management (standard), Intelligent Provisioning (standard), iLO Advanced (optional), Insight Control (optional)

### Form Factor

Rack (2U)

Rack (2U)

### Warranty

Server Warranty includes 3-Year Parts, 1-Year Labor, 1-Year Onsite support with next business day response

## E5-2600v4 Series Pre-configured Models

### [SKU Number]

849879-B21

849878-B21

### Model Name

HPE Apollo 4200 Gen9 E5-2620v4 SFF Server

HPE Apollo 4200 Gen9 E5-2620v4 LFF Server

### Processor

Intel® Xeon® E5-2620v4

Intel® Xeon® E5-2620v4

### Number of Processors

One

### Memory

16GB (1x16GB Registered DIMMs, 2400 MHz)

NOTE:NOTE: with the E5-2620v4 this memory DIMM will only operate at 2133MHz

## Pre-configured Models

16GB (1x16GB Registered DIMMs, 2400 MHz)

NOTE:NOTE: with the E5-2620v4 this memory DIMM will only operate at 2133MHz

### Network Controller

HPE Embedded 1Gb Ethernet 2-port 361i Adapter

### Storage Controller

HPE Flexible Smart Array P840ar/2G Controller

HPE Flexible Smart Array P840ar/2G Controller

### Hard Drive

None ship standard

22SFF hard drive blanks

None ship standard

10 LFF hard drive blanks

### Internal Storage

48 SFF HDD Bays and optional 2SFF Rear Cage Kit or 6SFF Rear Cage Kit

28 LFF HDD Bays and optional 4LFF Rear Cage Kit, 2SFF Rear Cage Kit, or 6SFF Rear Cage Kit

### PCI-Express Slots

2 PCIe slots and FlexibleLOM (+3 PCIe slots available with upgrade to second processor and optional 2 FHHL slots available with purchase of 2SFF and 2FHHL Rear Cage Kit)

2 PCIe slots and FlexibleLOM (+3 PCIe slots available with upgrade to second processor)

### Power Supply

(1) HPE 1400W Flex Slot Platinum Power Supply

(1) HPE 1400W Flex Slot Platinum Power Supply

### Fans

4 fans

4 fans

### Management

iLO Management (standard), Intelligent Provisioning (standard), iLO Advanced (optional), Insight Control (optional)

### Form Factor

Rack (2U)

Rack (2U)

### Warranty

Server Warranty includes 3-Year Parts, 1-Year Labor, 1-Year Onsite support with next business day response

NOTE:NOTE: UEFI is the standard default for all Pre-configured models

## Configuration Information - Factory Integrated Models

**NOTE:** This section lists some of the steps required to configure a Factory Integrated Model. To ensure only valid configurations are ordered, Hewlett Packard Enterprise recommends the use of a Hewlett Packard Enterprise approved configurator. Contact your local sales representative for information on configurable product offerings and requirements.

- Factory Integrated Models must start with a CTO Server.
- FIO indicates that this option is only available as a factory installable option.
- All Factory Integrated Models will be populated with sufficient hard drive blanks based on the number of initial hard drives ordered with the server.
- Some options may not be integrated at the factory. Contact your local sales representative for additional information.

### Step 1: Base Configuration (choose one of the following configurable models)

CTO Server	HPE Apollo 4200 Gen9 LFF CTO Server	HPE Apollo 4200 Gen9 SFF CTO Server
<b>SKU Number</b>	808027-B21	808028-B21
<b>Processor</b>	2 (optional) x HPE Smart Socket Guide	
<b>DIMM Slots</b>	16 DIMM slots for RDIMM, LRDIMM DDR4 Memory	
<b>Storage Controller</b>	HPE Smart Array P840ar, plus HPE Dynamic Smart Array B140i , optional HPE Flexible Smart Array or Smart HBA controller	
<b>PCIe</b>	2 PCIe slots and FlexibleLOM (Plus FHHL Riser option+3 PCI slots available with upgrade to second processor)	
<b>Drive Cage</b>	24 LFF Hot Plug and optional 4LFF Rear Cage Kit, , 2SFF Rear Cage Kit, or 6SFF Rear Cage Kit	48 SFF Hot Plug and optional 2 SFF Rear Cage Kit or 6 SFF Rear Cage Kit
<b>Network Controller</b>	HPE Embedded 1Gb Ethernet 2-port 361i Adapter, plus optional HPE FlexibleLOM or stand up card	
<b>Fans</b>	4 fans standard for 1P, 5 fans standard for 2P, plus redundant fan option	4 fans standard for 1P, 5 fans standard for 2P, plus redundant fan option
<b>Management</b>	iLO Management (standard), Intelligent Provisioning (standard), iLO Advanced (optional), Insight Control (optional)	
<b>USB</b>	1 front, 2 rear, 1 internal	1 front, 2 rear, 1 internal

### Step 2: Choose Required Options (only one of the following from each list unless otherwise noted)

<b>HPE Processors</b>	E5-2600v4 Series Processors	
	HPE Apollo 4200 Gen9 Intel® Xeon® E5-2699v4 (2.2GHz/22-core/55MB/145W) FIO Processor Kit	830754-L21
	HPE Apollo 4200 Gen9 Intel® Xeon® E5-2698v4 (2.2GHz/20-core/50MB/135W) FIO Processor Kit	830752-L21
	HPE Apollo 4200 Gen9 Intel® Xeon® E5-2697v4 (2.3GHz/18-core/45MB/145W) FIO Processor Kit	830750-L21
	HPE Apollo 4200 Gen9 Intel® Xeon® E5-2695v4 (2.1GHz/18-core/45MB/120W) FIO Processor Kit	830748-L21
	HPE Apollo 4200 Gen9 Intel® Xeon® E5-2697Av4 (2.6GHz/16-core/40MB/145W) FIO Processor Kit	841372-L21
	HPE Apollo 4200 Gen9 Intel® Xeon® E5-2683v4 (2.1GHz/16-core/40MB/120W) FIO Processor Kit	839744-L21
	HPE Apollo 4200 Gen9 Intel® Xeon® E5-2690v4 (2.6GHz/14-core/35MB/135W) FIO Processor Kit	830746-L21
	HPE Apollo 4200 Gen9 Intel® Xeon® E5-2680v4 (2.4GHz/14-core/35MB/120W) FIO Processor Kit	830742-L21
	HPE Apollo 4200 Gen9 Intel® Xeon® E5-2660v4 (2.0GHz/14-core/35MB/105W) FIO Processor Kit	830736-L21
	HPE Apollo 4200 Gen9 Intel® Xeon® E5-2650Lv4 (1.7GHz/14-core/35MB/65W) FIO Processor Kit	830732-L21
	HPE Apollo 4200 Gen9 Intel® Xeon® E5-2650v4 (2.2GHz/12-core/30MB/105W) FIO Processor Kit	830734-L21
	HPE Apollo 4200 Gen9 Intel® Xeon® E5-2640v4 (2.4GHz/10-core/25MB/90W) FIO Processor Kit	830728-L21

## Configuration Information - Factory Integrated Models

HPE Apollo 4200 Gen9 Intel® Xeon® E5-2630v4 (2.2GHz/10-core/25MB/85W) FIO Processor Kit	830724-L21
HPE Apollo 4200 Gen9 Intel® Xeon® E5-2667v4 (3.2GHz/8-core/25MB/135W) FIO Processor Kit	830738-L21
HPE Apollo 4200 Gen9 Intel® Xeon® E5-2620v4 (2.1GHz/8-core/20MB/85W) FIO Processor Kit	830718-L21
HPE Apollo 4200 Gen9 Intel® Xeon® E5-2609v4 (1.7GHz/8-core/20MB/85W) FIO Processor Kit	830716-L21
HPE Apollo 4200 Gen9 Intel® Xeon® E5-2643v4 (3.4GHz/6-core/20MB/135W) FIO Processor Kit	830730-L21
HPE Apollo 4200 Gen9 Intel® Xeon® E5-2603v4 (1.7GHz/6-core/15MB/85W) FIO Processor Kit	830714-L21
HPE Apollo 4200 Gen9 Intel® Xeon® E5-2637v4 (3.5GHz/4-core/15MB/135W) FIO Processor Kit	830726-L21
HPE Apollo 4200 Gen9 Intel® Xeon® E5-2623v4 (2.6GHz/4-core/10MB/85W) FIO Processor Kit	830720-L21
E5-2600v3 Series Processors	
HPE Apollo 4200 Gen9 Intel® Xeon® E5-2699v3 (2.3GHz/18-core/45MB/145W) FIO Processor Kit	821792-L21
HPE Apollo 4200 Gen9 Intel® Xeon® E5-2698v3 (2.3GHz/16-core/40MB/135W) FIO Processor Kit	803319-L21
HPE Apollo 4200 Gen9 Intel® Xeon® E5-2697v3 (2.6GHz/14-core/35MB/145W) FIO Processor Kit	821791-L21
HPE Apollo 4200 Gen9 Intel® Xeon® E5-2695v3 (2.3GHz/14-core/35MB/120W) FIO Processor Kit	803318-L21
HPE Apollo 4200 Gen9 Intel® Xeon® E5-2683v3 (2GHz/14-core/35MB/120W) FIO Processor Kit	803315-L21
HPE Apollo 4200 Gen9 Intel® Xeon® E5-2690v3 (2.6GHz/12-core/30MB/135W) FIO Processor Kit	803317-L21
HPE Apollo 4200 Gen9 Intel® Xeon® E5-2680v3 (2.5GHz/12-core/30MB/120W) FIO Processor Kit	803314-L21
HPE Apollo 4200 Gen9 Intel® Xeon® E5-2670v3 (2.3GHz/12-core/30MB/120W) FIO Processor Kit	803313-L21
HPE Apollo 4200 Gen9 Intel® Xeon® E5-2650Lv3 (1.8GHz/12-core/30MB/65W) FIO Processor Kit	803309-L21
HPE Apollo 4200Gen9 Intel® Xeon® E5-2660v3 (2.6GHz/10-core/25MB/105W) FIO Processor Kit	803311-L21
HPE Apollo 4200Gen9 Intel® Xeon® E5-2650v3 (2.3GHz/10-core/25MB/105W) FIO Processor Kit	803310-L21
HPE Apollo 4200 Gen9 Intel® Xeon® E5-2667v3 (3.2GHz/8-core/20MB/135W) FIO Processor Kit	803312-L21
HPE Apollo 4200 Gen9 Intel® Xeon® E5-2640v3 (2.6GHz/8-core/20MB/90W) FIO Processor Kit	803308-L21
HPE Apollo 4200 Gen9 Intel® Xeon® E5-2630Lv3 (1.8GHz/8-core/20MB/55W) FIO Processor Kit	803305-L21
HPE Apollo 4200 Gen9 Intel® Xeon® E5-2630v3 (2.4GHz/8-core/20MB/85W) FIO Processor Kit	803306-L21
HPE Apollo 4200 Gen9 Intel® Xeon® E5-2643v3 (3.4GHz/6-core/20MB/135W) FIO Processor Kit	803301-L21
HPE Apollo 4200 Gen9 Intel® Xeon® E5-2620v3 (2.4GHz/6-core/15MB/85W) FIO Processor Kit	803300-L21
HPE Apollo 4200 Gen9 Intel® Xeon® E5-2609v3 (1.9GHz/6-core/15MB/85W) FIO Processor Kit	803303-L21
HPE Apollo 4200 Gen9 Intel® Xeon® E5-2603v3 (1.6GHz/6-core/15MB/85W) FIO Processor Kit	803302-L21
HPE Apollo 4200 Gen9 Intel® Xeon® E5-2637v3 (3.5GHz/4-core/15MB/135W) FIO Processor Kit	803307-L21
HPE Apollo 4200 Gen9 Intel® Xeon® E5-2637v3 (3.0GHz/4-core/15MB/135W) FIO Processor Kit	803304-L21

**NOTE:** Up to 2 processors supported. Mixing different processor models is not supported. If 2 processors are desired, select one xxxxxx-L21 and one xxxxxx-B21.

**NOTE:** xxxxxx-B21 processors ship with 1 additional FAN for factory or field installation.

**NOTE:** DDR4 speed is the maximum memory speed of the processor. Actual memory speed may depend on the quantity and type of DIMMs installed.

**NOTE:** When v4 Processor is selected, then only PC4-2400T Memory Kit can be selected.

**NOTE:** When v3 Processor is selected, then only PC4-2133P Memory Kit can be selected.

**NOTE:** For the Intel® C600 Chipset E5-2600 Series, the letter preceding the model number indicates the Product Line (E3, E5, E7); 2600x v#, 2=number of CPUs in a Node, 6 is socket/segment designation, 00=Processor SKU, x=L for low power SKUs and v# (not yet designated)=version number.

**HPE Memory** **NOTE:** Select one or more memory

**NOTE:** LRDIMM, RDIMM are all distinct memory technologies and cannot be mixed within a server. The majority of ProLiant Gen9 servers support LRDIMM and RDIMM

## Configuration Information - Factory Integrated Models

**NOTE:** HPE memory from previous generation servers are not qualified or warranted with this HPE ProLiant Server. HPE SmartMemory is required to realize the memory performance improvements and enhanced functionality listed in this document for Gen9

**NOTE:** If only one processor is installed, only half of the total DIMM slots are available. When populating with two processors all DIMM slots are available

**NOTE:** Kits described as LP include Low Power DIMMs. For more information on ProLiant Energy Efficient Features, see: <http://www.hp.com/go/proliant-energy-efficient>.

**NOTE:** Depending on the memory configuration and processor model, the memory speed may run at 2400MHz, 2133MHz, 1866MHz, 1600MHz or 1333MHz. Please see Memory Population Table or the Online Memory Configuration Tool at: <http://www.hp.com/go/ddr4config>

Registered DIMMs (RDIMMs) for E5-2600v4 Series

HPE 32GB (1x32GB) Dual Rank x4 DDR4-2400 CAS-17-17-17 Registered Memory Kit 805351-B21

HPE 16GB (1x16GB) Dual Rank x4 DDR4-2400 CAS-17-17-17 Registered Memory Kit 836220-B21

HPE 16GB (1x16GB) Single Rank x4 DDR4-2400 CAS-17-17-17 Registered Memory Kit 805349-B21

HPE 8GB (1x8GB) Single Rank x8 DDR4-2400 CAS-17-17-17 Registered Memory Kit 805347-B21

Load Reduced DIMMs (LRDIMMs) for E5-2600v4 Series

HPE 64GB (1x64GB) Quad Rank x4 DDR4-2400 CAS-17-17-17 Load Reduced Memory Kit 805358-B21

HPE 32GB (1x32GB) Dual Rank x4 DDR4-2400 CAS-17-17-17 Load Reduced Memory Kit 805353-B21

Registered DIMMs (RDIMMs) for E5-2600v3 Series

HPE 32GB (1x32GB) Dual Rank x4 DDR4-2133 CAS-15-15-15 Registered Memory Kit 728629-B21

HPE 16GB (1x16GB) Dual Rank x4 DDR4-2133 CAS-15-15-15 Registered Memory Kit 726719-B21

HPE 8GB (1x8GB) Dual Rank x8 DDR4-2133 CAS-15-15-15 Registered Memory Kit 759934-B21

HPE 8GB (1x8GB) Single Rank x4 DDR4-2133 CAS-15-15-15 Registered Memory Kit 726718-B21

HPE 4GB (1x4GB) Single Rank x8 DDR4-2133 CAS-15-15-15 Registered Memory Kit 726717-B21

Load Reduced DIMMs (LRDIMMs) for E5-2600v3 Series

HPE 64GB (1x64GB) Quad Rank x4 DDR4-2133 CAS-15-15-15 Load Reduced Memory Kit 726724-B21

HPE 32GB (1x32GB) Quad Rank x4 DDR4-2133 CAS-15-15-15 Load Reduced Memory Kit 726722-B21

HPE 16GB (1x16GB) Dual Rank x4 DDR4-2133 CAS-15-15-15 Load Reduced Memory Kit 726720-B21

### HPE Power Supplies

**NOTE:** Prior to selecting a power supply option, it is highly recommended that you review your server configuration in the HPE Power Advisor tool to determine the right size power supply for your server configuration. The HPE Power Advisor is located at: <http://www.hp.com/go/hppoweradvisor>.

**NOTE:** Mixing of power supplies in the same server is not supported. All power supplies must be of the same input voltage, output rating, and efficiency rating. If non-matching power supplies are installed, you may receive an error message and/or experience operational issues with your server.

HPE 800W Flex Slot Titanium Hot Plug Power Supply Kit 720482-B21

HPE 800W Flex Slot Universal Hot Plug Power Supply Kit 720484-B21

HPE 800W Flex Slot Platinum Hot Plug Power Supply Kit 720479-B21

HPE 800W Flex Slot -48VDC Hot Plug Power Supply Kit 720480-B21

HPE 1400W Flex Slot Platinum Plus Hot Plug Power Supply Kit 720620-B21

**NOTE:** The above power supply options are all 80Plus Platinum-certified with an efficiency rating of up to 94%. Support for HPE Power Discovery Services is included with the 1400W Flex Slot option. Power specifications and technical content for all HPE Server power supplies can be found at <http://www.hp.com/go/proliant/powersupply>.

**NOTE:** Maximum of 2 Flex Slot PS per platform.

### Step 3: Choose Additional Factory Integrated Options (only one of the following from each list unless otherwise noted)

## Configuration Information - Factory Integrated Models

<b>HPE Hard Drives</b>	<b>6-pack SATA Hot Plug LFF (3.5-inch) Low Profile Hard Drive Bundles</b>	
	HPE 8TB 6G SATA 7.2K rpm LFF (3.5in) 512e Low Profile Midline 1yr Wty 6-pack FIO Hard drive Bundle	867261-B21
	<b>NOTE:</b> HPE Apollo 4200 Gen9 Redundant Fan Kit (806562-B21) and ROM version 1.50 or later are required.	
	HPE 6TB 6G SATA 7.2K rpm LFF (3.5in) 512e Low Profile Midline 1yr Wty 6-pack FIO Hard drive Bundle	867267-B21
	HPE 4TB 6G SATA 7.2K rpm LFF (3.5in) 512e Low Profile Midline 1yr Wty 6-pack FIO Hard drive Bundle	867265-B21
	<b>6-pack SAS Hot Plug LFF (3.5-inch) Low Profile Hard Drive Bundles</b>	
<b>HPE Unique Options</b>	HPE 8TB 12G SAS 7.2K rpm LFF (3.5in) 512e Low Profile Midline 1yr Wty 6-pack FIO Hard drive Bundle	867263-B21
	<b>NOTE:</b> HPE Apollo 4200 Gen9 Redundant Fan Kit (806562-B21) and ROM version 1.50 or later are required.	
	HPE 6TB 12G SAS 7.2K rpm LFF (3.5in) 512e Low Profile Midline 1yr Wty 6-pack FIO Hard drive Bundle	867271-B21
	HPE 4TB 12G SAS 7.2K rpm LFF (3.5in) 512e Low Profile Midline 1yr Wty 6-pack FIO Hard drive Bundle	867269-B21
	HPE Apollo 4200 Gen9 Smart HBA H240 FIO Rear Cable Kit	838823-B21
	<b>NOTE:</b> Required when HPE H240 12Gb 2-ports Int Smart Host Bus Adapter (726907-B21) is selected.	
	HPE SAS Smart HBA H240 FIO Controller Mode for Rear Storage	838827-B21
	<b>NOTE:</b> Cannot be selected if P/N: 813545-B21, 813546-B21, or 838830-B21 is selected with HPE Apollo 4200 Gen9 LFF Rear HDD Cage Kit (806563-B21) or HPE Apollo 4200 Gen9 2SFF and 2FHHL Kit (806564-B21).	
	<b>NOTE:</b> When one of the HPE Apollo 4200 Gen9 LFF Rear HDD Cage Kit (806563-B21) or HPE Apollo 4200 Gen9 2SFF and 2FHHL Kit (806564-B21) is selected, one of the HPE SATA B140i Mode for Rear Storage (813545-B21), HPE 2nd HDD Cage FIO Controller Mode for Rear Storage (813546-B21), HPE SAS Smart HBA H240 FIO Controller Mode for Rear Storage (838827-B21), or HPE SAS Smart Array P440 FIO Controller Mode for Rear Storage (838830-B21) is required.	
	<b>NOTE:</b> The Rear HDDs will be under the optional HPE H240 12Gb 2-ports Int Smart Host Bus Adapter (726907-B21) when HPE SAS Smart HBA H240 FIO Controller Mode for Rear Storage (838827-B21) is selected.	
HPE SATA B140i FIO Controller Mode for Rear Storage	813545-B21	
<b>NOTE:</b> Cannot be selected if P/N: 813546-B21, 838827-B21, or 838830-B21 is selected with HPE Apollo 4200 Gen9 LFF Rear HDD Cage Kit (806563-B21) or HPE Apollo 4200 Gen9 2SFF and 2FHHL Kit (806564-B21).		
<b>NOTE:</b> When one of the HPE Apollo 4200 Gen9 LFF Rear HDD Cage Kit (806563-B21) or HPE Apollo 4200 Gen9 2SFF and 2FHHL Kit (806564-B21) is selected, one of the HPE SATA B140i Mode for Rear Storage (813545-B21), HPE 2nd HDD Cage FIO Controller Mode for Rear Storage (813546-B21), HPE SAS Smart HBA H240 FIO Controller Mode for Rear Storage (838827-B21), or HPE SAS Smart Array P440 FIO Controller Mode for Rear Storage (838830-B21) is required.		
<b>NOTE:</b> Can only be selected with SATA drives for rear HDDs.		
HPE 2 <sup>nd</sup> HDD Cage FIO Controller Mode for Rear Storage	813546-B21	
<b>NOTE:</b> When HPE Apollo 4200 Gen9 LFF Rear HDD Cage Kit or HPE Apollo 4200 Gen9 2SFF and 2FHHL Kit is selected, one of HPE SATA B140i Mode for Rear Storage or HPE SAS Controller Mode for Rear Storage needs to be selected.		
HPE SAS Smart Array P440 FIO Controller Mode for Rear Storage	838830-B21	
<b>NOTE:</b> Cannot be selected if P/N: 813545-B21, 813546-B21, or 838827-B21 is selected with HPE Apollo 4200 Gen9 LFF Rear HDD Cage Kit (806563-B21) or HPE Apollo 4200 Gen9 2SFF and 2FHHL Kit (806564-B21).		

## Configuration Information - Factory Integrated Models

**NOTE:** When one of the HPE Apollo 4200 Gen9 LFF Rear HDD Cage Kit (806563-B21) or HPE Apollo 4200 Gen9 2SFF and 2FHHL Kit (806564-B21) is selected, one of the HPE SATA B140i Mode for Rear Storage (813545-B21), HPE 2nd HDD Cage FIO Controller Mode for Rear Storage (813546-B21), HPE SAS Smart HBA H240 FIO Controller Mode for Rear Storage (838827-B21), or HPE SAS Smart Array P440 FIO Controller Mode for Rear Storage (838830-B21) is required.

**NOTE:** The Rear HDDs will be under the optional HPE Smart Array P440/4GB FBWC 12Gb 1-port Int SAS Controller (726821-B21) when HPE SAS Smart Array P440 FIO Controller Mode for Rear Storage (838830-B21) is selected.

**Rack Options** HPE Apollo 4200 Gen9 FIO Strap Shipping Bracket 822640-B21

**BIOS Mode** HPE Legacy FIO Mode 758969-B22

**NOTE:** Cannot be selected with HPE SATA B140i Mode for Rear Storage (813545-B21) or HPE Dual 8GB MicroSD EM USB Kit (741279-B21)

### Step 4: Choose More Options for Factory Integration from Core and Additional Options sections below.

**CAUTION:** Hewlett Packard Enterprise recommends that a minimum of two people are required for all Rack Server installations. Please refer to your installation instructions for proper tools and number of people to use for any installation.



## Core Options

**NOTE:** Some options may not be integrated at the factory. To ensure only valid configurations are ordered, Hewlett Packard Enterprise recommends the use of a Hewlett Packard Enterprise approved configurator. Contact your local sales representative for additional information.

<b>HPE Unique Options</b>	<p>HPE Apollo 4200 Gen9 LFF Rear HDD Cage Kit <span style="float: right;">806563-B21</span></p> <p><b>NOTE:</b> The LFF Rear HDD cage kit supports an additional four LFF drives.</p> <p><b>NOTE:</b> The LFF Rear HDD cage only applies to the LFF model.</p> <p><b>CAUTION:</b> Do not operate the server with any of the rear drive cage bays empty. To maintain proper airflow and sufficient cooling in the rear drive cage, all drive bays in this cage should have a drive or a drive blank. Hewlett Packard Enterprise recommends installing at least one drive in the rear drive cage before operating the Apollo 4200.</p>
	<p>HPE Apollo 4200 Gen9 2SFF and 2FHHL Kit <span style="float: right;">806564-B21</span></p> <p><b>NOTE:</b> This part supports an additional 2SFF drives and a riser that supports 2 full-height half-length PCIe slots.</p> <p><b>NOTE:</b> To access PCIe slots 3-4, this above 2SFF and 2FHHL Kit must be purchased</p> <p><b>NOTE:</b> Using optional FHHL kit (PN: 806564-B21), the two PCIe slots 3-4 are available by using slot 2 as a standup expansion slot.</p> <p><b>CAUTION:</b> Do not operate the server with any of the rear drive cage bays empty. To maintain proper airflow and sufficient cooling in the rear drive cage, all drive bays in this cage should have a drive or a drive blank. Hewlett Packard Enterprise recommends installing at least one drive in the rear drive cage before operating the Apollo 4200.</p>
	<p>HPE Apollo 4200 Gen9 6SFF Rear Hard Drive Cage Kit <span style="float: right;">838833-B21</span></p> <p><b>NOTE:</b> The 6SFF Rear HDD cage kit supports an additional six SFF drives.</p> <p><b>NOTE:</b> One of the below 6 FIO controller mode combinations is required when the 6SFF Rear HDD cage kit (838833-B21) is selected.</p> <p><b>NOTE:</b> When HPE 2nd HDD Cage FIO Controller Mode for Rear Storage (813546-B21) + HPE SATA B140i FIO Controller Mode for Rear Storage (813545-B21) is selected, the SFF Drive number 49-52 are under 2nd HDD cage controller and SFF Drive number 53-54 are under HPE SATA B140i Controller. The SFF Drive number 53-54 have to be SATA HDDs. This combination is for SFF model only.</p> <p><b>NOTE:</b> When HPE 2nd HDD Cage FIO Controller Mode for Rear Storage (813546-B21) + HPE SAS Smart HBA H240 FIO Controller Mode for Rear Storage (838827-B21) is selected, the SFF Drive number 49-52 are under 2nd HDD cage controller and SFF Drive number 53-54 are under optional HPE SAS Smart HBA H240 controller. The HPE H240 12Gb 2-ports Int Smart Host Bus Adapter (726907-B21) is required. This combination is for SFF model only.</p> <p><b>NOTE:</b> When HPE 2nd HDD Cage FIO Controller Mode for Rear Storage (813546-B21) + HPE SAS Smart Array P440 FIO Controller Mode for Rear Storage (838830-B21) is selected, the SFF Drive number 49-52 are under 2nd HDD cage controller and SFF Drive number 53-54 are under optional HPE SAS Smart Array P440 controller. The HPE Smart Array P440/4GB FBWC 12Gb 1-port Int SAS Controller (726821-B21) is required. This combination is for SFF model only.</p> <p><b>NOTE:</b> When HPE SAS Smart HBA H240 FIO Controller Mode for Rear Storage (838827-B21) is selected only, all rear 6SFF HDDs are under optional HPE SAS Smart HBA H240 controller. The HPE H240 12Gb 2-ports Int Smart Host Bus Adapter (726907-B21) is required. This mode is for both LFF and SFF models.</p> <p><b>NOTE:</b> When HPE SAS Smart Array P440 FIO Controller Mode for Rear Storage (838830-B21) is selected only, all rear 6SFF HDDs are under optional HPE SAS Smart Array P440 controller. The HPE Smart Array P440/4GB FBWC 12Gb 1-port Int SAS Controller (726821-B21) is required. This mode is for both LFF and SFF models.</p>

## Core Options

**NOTE:** When HPE SATA B140i FIO Controller Mode for Rear Storage (813545-B21) is selected only, all rear 6SFF HDDs are under HPE SATA B140i controller. All the 6SFF Drives have to be SATA HDDs. This mode is for both LFF and SFF models.

**CAUTION:** Do not operate the server with any of the rear drive cage bays empty. To maintain proper airflow and sufficient cooling in the rear drive cage, all drive bays in this cage should have a drive or a drive blank. Hewlett Packard Enterprise recommends installing at least one drive in the rear drive cage before operating the Apollo 4200.

HPE Apollo 4200 Gen9 Smart Array P440 Rear Cable Kit 841374-B21

**NOTE:** This part is required when the rear HDDs are controlled by the optional HPE Smart Array P440/4GB FBWC 12Gb 1-port Int SAS Controller (726821-B21).

HPE Apollo 4200 Gen9 Redundant Fan Kit 806562-B21

**NOTE:** For 1 processor configurations, the HPE Apollo 4200 Gen9 Redundant Fan Kit (806562-B21) will ship 4 additional fans, for a total of 8 fans. There will be one spare fan in the carton for the future upgrade to 2 processors.

**NOTE:** For 2 processor configurations, the HPE Apollo 4200 Gen9 Redundant Fan Kit (806562-B21) will ship 5 fans for redundant function

HPE 2U Shelf-Mount Adjustable Rail Kit 822731-B21

HPE Apollo 4200 Gen9 Strap Shipping Bracket 822640-B21

**NOTE:** This part is used for shipping that is integrated in a rack.

HPE Apollo 4200 Gen9 Dedicated iLO Management Port Kit 806565-B21

**NOTE:** This is a management module for the Apollo 4200 Gen9 Server to provide a rear dedicated 1Gb management port.

HPE Apollo 4200 Gen9 Intel® Xeon® E5-2699v4 (2.2GHz/22-core/55MB/145W) Processor Kit 830754-B21

### 20-Core Processors

HPE Apollo 4200 Gen9 Intel® Xeon® E5-2698v4 (2.2GHz/20-core/50MB/135W) Processor Kit 830752-B21

### 18-Core Processors

HPE Apollo 4200 Gen9 Intel® Xeon® E5-2699v3 (2.3GHz/18-core/45MB/145W) Processor Kit 821792-B21

HPE Apollo 4200 Gen9 Intel® Xeon® E5-2697v4 (2.3GHz/18-core/45MB/145W) Processor Kit 830750-B21

HPE Apollo 4200 Gen9 Intel® Xeon® E5-2695v4 (2.1GHz/18-core/45MB/120W) Processor Kit 830748-B21

### 16-Core Processors

HPE Apollo 4200 Gen9 Intel® Xeon® E5-2698v3 (2.3GHz/16-core/40MB/135W) Processor Kit 803319-B21

HPE Apollo 4200 Gen9 Intel® Xeon® E5-2697Av4 (2.6GHz/16-core/40MB/145W) Processor Kit 841372-B21

HPE Apollo 4200 Gen9 Intel® Xeon® E5-2683v4 (2.1GHz/16-core/40MB/120W) Processor Kit 830744-B21

### 14-Core Processors

HPE Apollo 4200 Gen9 Intel® Xeon® E5-2697v3 (2.6GHz/14-core/35MB/145W) Processor Kit 821791-B21

HPE Apollo 4200 Gen9 Intel® Xeon® E5-2695v3 (2.3GHz/14-core/35MB/120W) Processor Kit 803318-B21

HPE Apollo 4200 Gen9 Intel® Xeon® E5-2683v3 (2GHz/14-core/35MB/120W) Processor Kit 803315-B21

HPE Apollo 4200 Gen9 Intel® Xeon® E5-2690v4 (2.6GHz/14-core/35MB/135W) Processor Kit 830746-B21

HPE Apollo 4200 Gen9 Intel® Xeon® E5-2680v4 (2.4GHz/14-core/35MB/120W) Processor Kit 830742-B21

HPE Apollo 4200 Gen9 Intel® Xeon® E5-2660v4 (2.0GHz/14-core/35MB/105W) Processor Kit 830736-B21

HPE Apollo 4200 Gen9 Intel® Xeon® E5-2650Lv4 (1.7GHz/14-core/35MB/65W) Processor Kit 830732-B21

### 12-Core Processors

HPE Apollo 4200 Gen9 Intel® Xeon® E5-2690v3 (2.6GHz/12-core/30MB/135W) Processor Kit 803317-B21

HPE Apollo 4200 Gen9 Intel® Xeon® E5-2680v3 (2.5GHz/12-core/30MB/120W) Processor Kit 803314-B21

HPE Apollo 4200 Gen9 Intel® Xeon® E5-2670v3 (2.3GHz/12-core/30MB/120W) Processor Kit 803313-B21

HPE Apollo 4200 Gen9 Intel® Xeon® E5-2650Lv3 (1.8GHz/12-core/30MB/65W) Processor Kit 803309-B21

## Core Options

HPE Apollo 4200 Gen9 Intel® Xeon® E5-2650v4 (2.2GHz/12-core/30MB/105W) Processor Kit	830734-B21
HPE Apollo 4200Gen9 Intel® Xeon® E5-2660v3 (2.6GHz/10-core/25MB/105W) Processor Kit	803311-B21
HPE Apollo 4200Gen9 Intel® Xeon® E5-2650v3 (2.3GHz/10-core/25MB/105W) Processor Kit	803310-B21
HPE Apollo 4200 Gen9 Intel® Xeon® E5-2640v4 (2.4GHz/10-core/25MB/90W) Processor Kit	830728-B21
HPE Apollo 4200 Gen9 Intel® Xeon® E5-2630v4 (2.2GHz/10-core/25MB/85W) Processor Kit	830724-B21

### 8-Core Processors

HPE Apollo 4200 Gen9 Intel® Xeon® E5-2667v3 (3.2GHz/8-core/20MB/135W) Processor Kit	803312-B21
HPE Apollo 4200 Gen9 Intel® Xeon® E5-2640v3 (2.6GHz/8-core/20MB/90W) Processor Kit	803308-B21
HPE Apollo 4200 Gen9 Intel® Xeon® E5-2630Lv3 (1.8GHz/8-core/20MB/55W) Processor Kit	803305-B21
HPE Apollo 4200 Gen9 Intel® Xeon® E5-2630v3 (2.4GHz/8-core/20MB/85W) Processor Kit	803306-B21
HPE Apollo 4200 Gen9 Intel® Xeon® E5-2667v4 (3.2GHz/8-core/25MB/135W) Processor Kit	830738-B21
HPE Apollo 4200 Gen9 Intel® Xeon® E5-2620v4 (2.1GHz/8-core/20MB/85W) Processor Kit	830718-B21
HPE Apollo 4200 Gen9 Intel® Xeon® E5-2609v4 (1.7GHz/8-core/20MB/85W) Processor Kit	830716-B21

### 6-Core Processors

HPE Apollo 4200 Gen9 Intel® Xeon® E5-2643v3 (3.4GHz/6-core/20MB/135W) Processor Kit	803301-B21
HPE Apollo 4200 Gen9 Intel® Xeon® E5-2620v3 (2.4GHz/6-core/15MB/85W) Processor Kit	803300-B21
HPE Apollo 4200 Gen9 Intel® Xeon® E5-2609v3 (1.9GHz/6-core/15MB/85W) Processor Kit	803303-B21
HPE Apollo 4200 Gen9 Intel® Xeon® E5-2603v3 (1.6GHz/6-core/15MB/85W) Processor Kit	803302-B21
HPE Apollo 4200 Gen9 Intel® Xeon® E5-2643v4 (3.4GHz/6-core/20MB/135W) Processor Kit	830730-B21
HPE Apollo 4200 Gen9 Intel® Xeon® E5-2603v4 (1.7GHz/6-core/15MB/85W) Processor Kit	830714-B21
HPE Apollo 4200 Gen9 Intel® Xeon® E5-2637v3 (3.5GHz/4-core/15MB/135W) Processor Kit	803307-B21
HPE Apollo 4200 Gen9 Intel® Xeon® E5-2623v3 (3.0GHz/4-core/10MB/105W) Processor Kit	803304-B21
HPE Apollo 4200 Gen9 Intel® Xeon® E5-2637v4 (3.5GHz/4-core/15MB/135W) Processor Kit	830726-B21
HPE Apollo 4200 Gen9 Intel® Xeon® E5-2623v4 (2.6GHz/4-core/10MB/85W) Processor Kit	830720-B21

**NOTE:** Up to 2 processors supported.

**NOTE:** DDR4 speed is the maximum memory speed of the processor. Actual memory speed may depend on the quantity and type of DIMMs installed.

**NOTE:** xxxxxx-B21 processor kits ship with 1 additional FAN for factory of field installation.

## HPE Memory

### Registered DIMMs (RDIMMs) for E5-2600v3 Series

**NOTE:** The following memory is supported by the E5-2600v3 series Processors.

HPE 32GB (1x32GB) Dual Rank x4 DDR4-2133 CAS-15-15-15 Registered Memory Kit	728629-B21
HPE 16GB (1x16GB) Dual Rank x4 DDR4-2133 CAS-15-15-15 Registered Memory Kit	726719-B21
HPE 8GB (1x8GB) Dual Rank x8 DDR4-2133 CAS-15-15-15 Registered Memory Kit	759934-B21
HPE 8GB (1x8GB) Single Rank x4 DDR4-2133 CAS-15-15-15 Registered Memory Kit	726718-B21
HPE 4GB (1x4GB) Single Rank x8 DDR4-2133 CAS-15-15-15 Registered Memory Kit	726717-B21

**NOTE:** Depending on Processor selected this memory will run at 1600, 1866 or 2133MHz.

### Load Reduced DIMMs (LRDIMMs) for E5-2600v3 Series

**NOTE:** The following memory is supported by the E5-2600v3 series Processors.

HPE 64GB (1x64GB) Quad Rank x4 DDR4-2133 CAS-15-15-15 Load Reduced Memory Kit	726724-B21
HPE 32GB (1x32GB) Quad Rank x4 DDR4-2133 CAS-15-15-15 Load Reduced Memory Kit	726722-B21
HPE 16GB (1x16GB) Dual Rank x4 DDR4-2133 CAS-15-15-15 Load Reduced Memory Kit	726720-B21

**NOTE:** Depending on Processor selected this memory will run at 1600, 1866 or 2133MHz.

## Core Options

### Registered DIMMs (RDIMMs) for E5-2600v4 Series

**NOTE:** The following memory is supported by the E5-2600v4 series Processors.

HPE 32GB (1x32GB) Dual Rank x4 DDR4-2400 CAS-17-17-17 Registered Memory Kit	805351-B21
HPE 16GB (1x16GB) Dual Rank x4 DDR4-2400 CAS-17-17-17 Registered Memory Kit	836220-B21
HPE 16GB (1x16GB) Single Rank x4 DDR4-2400 CAS-17-17-17 Registered Memory Kit	805349-B21
HPE 8GB (1x8GB) Single Rank x8 DDR4-2400 CAS-17-17-17 Registered Memory Kit	805347-B21

**NOTE:** Depending on Processor selected this memory will run at 1866, 2133 or 2400MHz.

### Load Reduced DIMMs (LRDIMMs) for E5-2600v4 Series

**NOTE:** The following memory is supported by the E5-2600v4 series Processors.

HPE 64GB (1x64GB) Quad Rank x4 DDR4-2400 CAS-17-17-17 Load Registered Memory Kit	805358-B21
HPE 32GB (1x32GB) Dual Rank x4 DDR4-2400 CAS-17-17-17 Load Registered Memory Kit	805353-B21

**NOTE:** Depending on Processor selected this memory will run at 1866, 2133 or 2400MHz.

## HPE Drives

### SAS Hot Plug SFF (2.5-inch) Enterprise (ENT) Drives

HPE 1.8TB 12G SAS 10K rpm SFF (2.5-inch) SC Enterprise 512e 3yr Warranty Hard Drive	791034-B21
HPE 1.2TB 12G SAS 10K rpm SFF (2.5-inch) SC Enterprise 3yr Warranty Hard Drive	781518-B21
HPE 900GB 12G SAS 10K rpm SFF (2.5-inch) SC Enterprise 3yr Warranty Hard Drive	785069-B21
HPE 600GB 12G SAS 15K rpm SFF (2.5-inch) SC Enterprise 3yr Warranty Hard Drive	759212-B21
HPE 600GB 12G SAS 10K rpm SFF (2.5-inch) SC Enterprise 3yr Warranty Hard Drive	781516-B21
HPE 450GB 12G SAS 15K rpm SFF (2.5-inch) SC Enterprise 3yr Warranty Hard Drive	759210-B21
HPE 300GB 12G SAS 15K rpm SFF (2.5-inch) SC Enterprise 3yr Warranty Hard Drive	759208-B21
HPE 300GB 12G SAS 10K rpm SFF (2.5-inch) SC Enterprise 3yr Warranty Hard Drive	785067-B21
HPE 300GB 6G SAS 10K rpm SFF (2.5-inch) SC Enterprise 3yr Warranty Hard Drive	652564-B21

### SAS Hot Plug SFF (2.5-inch) Midline (MDL) Drives

HPE 1TB 6G SAS 7.2K rpm SFF (2.5-inch) SC Midline 1yr Warranty Hard Drive	652749-B21
HPE 500GB 6G SAS 7.2K rpm SFF (2.5-inch) SC Midline 1yr Warranty Hard Drive	652745-B21

### 12G SAS Hot Plug SFF (2.5-inch) Midline (MDL) Drives

HPE 1TB 12G SAS 7.2K rpm SFF (2.5in) SC Midline 1yr Warranty Hard Drive HPE 1TB 12G SAS 7.2K 2.5 MDL SC HDD	832514-B21
---	------------

HPE 480GB 6G SATA Value Endurance LFF 3.5-in LPC Enterprise Value 3yr Wty Solid State Drive	797303-B21
---	------------

HPE 1.6TB 6G SATA Mixed Use-2 LFF 3.5-in LPC 3yr Wty Solid State Drive	846788-B21
HPE 960GB 6G SATA Mixed Use-3 LFF 3.5-in LPC 3yr Wty Solid State Drive	832433-B21
HPE 1.6TB 6G SATA Read Intensive-2 LFF 3.5-in LPC 3yr Wty Solid State Drive	840993-B21
HPE 800GB 6G SATA Read Intensive-2 LFF 3.5-in LPC 3yr Wty Solid State Drive	840990-B21
HPE 480GB 6G SATA Read Intensive-2 LFF 3.5-in LPC 3yr Wty Solid State Drive	840987-B21

## Core Options

HPE 10TB 6G SATA 7.2K rpm LFF (3.5in) 512e Low Profile Midline 1yr Warranty Hard Drive <b>NOTE:</b> HPE Apollo 4200 Gen9 Redundant Fan Kit (806562-B21) and ROM version 1.50 or later are required.	857650-B21
HPE 8TB 6G SATA 7.2K rpm LFF (3.5in) 512e Low Profile Midline 1yr Warranty Hard Drive <b>NOTE:</b> HPE Apollo 4200 Gen9 Redundant Fan Kit (806562-B21) and ROM version 1.50 or later are required.	861596-B21
HPE 8TB 6G SATA 7.2K rpm LFF (3.5in) 512e LP Midline 1yr Warranty Hard Drive <b>NOTE:</b> HPE Apollo 4200 Gen9 Redundant Fan Kit (806562-B21) and ROM version 1.50 or later are required.	834028-B21
HPE 6TB 6G SATA 7.2K rpm LFF (3.5-inch) 512e Low Profile Midline 1yr Warranty Hard Drive	846785-B21
HPE 4TB 6G SATA 7.2K rpm LFF (3.5-inch) 512e Low Profile Midline 1yr Warranty Hard Drive	846783-B21
HPE 8TB 12G SAS 7.2K rpm LFF (3.5in) 512e LP Midline 1yr Warranty Hard Drive <b>NOTE:</b> HPE Apollo 4200 Gen9 Redundant Fan Kit (806562-B21) and ROM version 1.50 or later are required.	834031-B21
HPE 8TB 12G SAS 7.2K rpm LFF (3.5-inch) Low Profile Midline 1yr Warranty Hard Drive <b>NOTE:</b> HPE Apollo 4200 Gen9 Redundant Fan Kit (806562-B21) and ROM version 1.50 or later are required.	805337-B21
HPE 6TB 12G SAS 7.2K rpm LFF (3.5-inch) 512e Low Profile Midline 1yr Warranty Hard Drive	846998-B21
HPE 4TB 12G SAS 7.2K rpm LFF (3.5-inch) 512e Low Profile Midline 1yr Warranty Hard Drive	846996-B21
HPE 4TB 12G SAS 7.2K rpm LFF (3.5-inch) Low Profile Midline 1yr Warranty Hard Drive	833928-B21
HPE 3TB 12G SAS 7.2K rpm LFF (3.5in) Low Profile Midline 1yr Warranty Hard Drive	846530-B21
HPE 2TB 12G SAS 7.2K rpm LFF (3.5-inch) Low Profile Midline 1yr Warranty Hard Drive	833926-B21
HPE 1TB 12G SAS 7.2K rpm LFF (3.5in) Low Profile Midline 1yr Warranty Hard Drive	846526-B21
	797289-B21
	797291-B21
HPE 800GB 12G SAS Value Endurance LFF 3.5-in LPC Enterprise Performance 3yr Wty Solid State Drive	797299-B21
HPE 1.6TB 12G SAS Value Endurance LFF 3.5-in LPC Enterprise Performance 3yr Wty Solid State Drive	797301-B21
<b>12G SAS Hot Plug LFF (3.5-inch) Enterprise (ENT) Drives</b>	
HPE 300GB 12G SAS 15K rpm LFF (3.5-inch) Low Profile C Enterprise 3yr Warranty Hard Drive	797285-B21
HPE 450GB 12G SAS 15K rpm LFF (3.5-inch) Low Profile C Enterprise 3yr Warranty Hard Drive	797287-B21
HPE 600GB 12G SAS 15K rpm LFF (3.5-inch) Low Profile C Enterprise 3yr Warranty Hard Drive	797283-B21
<b>SAS Hot Plug LFF (3.5-inch) Midline (MDL) Drives</b>	
HPE 6TB 6G SAS 7.2K rpm LFF (3.5-inch) Low Profile Midline 1yr Warranty Hard Drive	797263-B21
HPE 4TB 6G SAS 7.2K rpm LFF (3.5-inch) Low Profile Midline 1yr Warranty Hard Drive	797267-B21

## Core Options

HPE 3TB 6G SAS 7.2K rpm LFF (3.5-inch) Low Profile Midline 1yr Warranty Hard Drive	797277-B21
HPE 2TB 6G SAS 7.2K rpm LFF (3.5-inch) Low Profile Midline 1yr Warranty Hard Drive	797279-B21
HPE 1TB 6G SAS 7.2K rpm LFF (3.5-inch) Low Profile Midline 1yr Warranty Hard Drive	797281-B21
<b>SATA Hot Plug SFF (2.5-inch) Midline (MDL) Drives</b>	
HPE 1TB 6G SATA 7.2K rpm SFF (2.5-inch) SC Midline 1yr Warranty Hard Drive	655710-B21
HPE 500GB 6G SATA 7.2K rpm SFF (2.5-inch) SC Midline 1yr Warranty Hard Drive	655708-B21
<b>SATA Hot Plug LFF (3.5-inch) Midline (MDL) Drives</b>	
HPE 8TB 6G SATA 7.2K rpm LFF (3.5-inch) Low Profile Midline 1yr Warranty	
<b>NOTE: HPE Apollo 4200 Gen9 Redundant Fan Kit (806562-B21) and ROM version 1.50 or later are required.</b>	805334-B21
HPE 6TB 6G SATA 7.2K rpm LFF (3.5-inch) Low Profile Midline 1yr Warranty Hard Drive	797269-B21
HPE 4TB 6G SATA 7.2K rpm LFF (3.5in) Low Profile Midline 1yr Warranty Hard Drive	861683-B21
HPE 3TB 6G SATA 7.2K rpm LFF (3.5in) Low Profile Midline 1yr Warranty Hard Drive	861688-B21
HPE 2TB 6G SATA 7.2K rpm LFF (3.5in) Low Profile Midline 1yr Warranty Hard Drive	861681-B21
HPE 1TB 6G SATA 7.2K rpm LFF (3.5in) Low Profile Midline 1yr Warranty Hard Drive	861686-B21
HPE 4TB 6G SATA 7.2K rpm LFF (3.5-inch) Low Profile Midline 1yr Warranty Hard Drive	797265-B21
HPE 3TB 6G SATA 7.2K rpm LFF (3.5-inch) Low Profile Midline 1yr Warranty Hard Drive	797271-B21
HPE 2TB 6G SATA 7.2K rpm LFF (3.5-inch) Low Profile Midline 1yr Warranty Hard Drive	797273-B21
HPE 1TB 6G SATA 7.2K rpm LFF (3.5-inch) Low Profile Midline 1yr Warranty Hard Drive	797275-B21
<b>12G SAS Hot Plug SFF (2.5-inch) SC Write Intensive Solid State Drives</b>	
HPE 1.6TB 12G SAS Write Intensive-1 SFF (2.5in) SC 3yr Wty Solid State Drive	846432-B21
HPE 800GB 12G SAS Write Intensive-1 SFF (2.5in) SC 3yr Wty Solid State Drive	846430-B21
<b>12G SAS Mixed Use Hot Plug SFF (2.5-inch) Solid State Drives</b>	
HPE 1.6TB 12G SAS Mixed Use-1 SFF (2.5in) SC 3yr Wty Solid State Drive	846436-B21
HPE 800GB 12G SAS Mixed Use-1 SFF (2.5in) SC 3yr Wty Solid State Drive	846434-B21
<b>12G SAS Hot Plug SFF (2.5-inch) Enterprise Mainstream Solid State Drives</b>	
HPE 1.6TB 12G SAS Mainstream Endurance SFF 2.5-in ENT Mainstream SC 3yr Wty H2 Solid State Drive	779176-B21
HPE 800GB 12G SAS Mainstream Endurance SFF 2.5-in ENT Mainstream SC 3yr Wty H2 Solid State Drive	779172-B21
HPE 400GB 12G SAS Mainstream Endurance SFF 2.5-in ENT Mainstream SC 3yr Wty H2 Solid State Drive	779168-B21
HPE 200GB 12G SAS Mainstream Endurance SFF 2.5-in ENT Mainstream SC 3yr Wty H2 Solid State Drive	779164-B21
HPE 400GB 12G SAS Write Intensive SFF 2.5-in SC 3yr Wty Solid State Drive	802582-B21
<b>12G SAS Hot Plug SFF (2.5-inch) Enterprise Value Solid State Drives</b>	
HPE 1.6TB 12G SAS Value Endurance SFF 2.5-in SC Enterprise Value 3yr Wty Solid State Drive	762263-B21
HPE 800GB 12G SAS Value Endurance SFF 2.5-in SC Enterprise Value 3yr Wty Solid State Drive	762261-B21
<b>6G SATA Hot Plug SFF (2.5-inch) Enterprise Mainstream Solid State Drives</b>	
HPE 800GB 6G SATA Mainstream Endurance SFF 2.5-in SC Enterprise Mainstream	691868-B21

## Core Options

3yr Wty Solid State Drive

### 6G SATA Hot Plug SFF (2.5-inch) Enterprise Value Solid State Drives

HPE 600GB 6G SATA Value Endurance SFF 2.5-in SC Enterprise Value 3yr Wty Solid State Drive 739898-B21

HPE 300GB 6G SATA Value Endurance SFF 2.5-in SC Enterprise Value 3yr Wty Solid State Drive 739888-B21

### 6G SATA Hot Plug SFF Value Endurance (2.5-inch) Enterprise Value G1 Solid State Drives

HPE 480GB 6G SATA Value Endurance SFF 2.5-in SC Enterprise Value 3yr Wty G1 Solid State Drive 756657-B21

HPE 240GB 6G SATA Value Endurance SFF 2.5-in SC Enterprise Value 3yr Wty G1 Solid State Drive 756636-B21

HPE 120GB 6G SATA Value Endurance SFF 2.5-in SC Enterprise Value 3yr Wty G1 Solid State Drive 756621-B21

### 6G SATA Hot Plug SFF (2.5-inch) Enterprise Light G1 Solid State Drives

HPE 960GB 6G SATA Light Endurance SFF 2.5-in SC Enterprise Light 3yr Wty G1 Solid State Drive 756601-B21

### 6G SATA Hot Plug SFF (2.5-inch) Enterprise Boot Solid State Drives

HPE 120GB 6G SATA Value Endurance SFF 2.5-in SC Enterprise Boot 3yr Wty Solid State Drive 717965-B21

HPE 80GB 6G SATA Value Endurance SFF 2.5-in SC Enterprise Boot 3yr Wty Solid State Drive 734360-B21

### 6G SATA Hot Plug SFF (2.5-inch) SC Read Intensive Solid State Drives

HPE 3.8TB SATA 6G Read Intensive SFF (2.5in) SC 3yr Wty Digitally Signed Firmware SSD 868830-B21  
**NOTE: This drive will ship in Q1 2017.**

HPE 3.84TB 6G SATA Read Intensive-3 SFF 2.5-in SC 3yr Wty Solid State Drive 816929-B21

HPE 1.92TB SATA 6G Read Intensive SFF (2.5in) SC 3yr Wty Digitally Signed Firmware SSD 868826-B21  
**NOTE: This drive will ship in Q1 2017.**

HPE 1.92TB 6G SATA Read Intensive SFF (2.5in) SC 1yr Warranty Solid State Drive 871770-B21

HPE 1.6TB 6G SATA Read Intensive-2 SFF 2.5-in SC 3yr Wty Solid State Drive 804605-B21

HPE 960GB SATA 6G Read Intensive SFF (2.5in) SC 3yr Wty Digitally Signed Firmware SSD 868822-B21  
**NOTE: This drive will ship in Q1 2017.**

HPE 960GB 6G SATA Read Intensive SFF (2.5in) SC 1yr Warranty Solid State Drive 871768-B21

HPE 800GB 6G SATA Read Intensive-2 SFF 2.5-in SC 3yr Wty Solid State Drive 804599-B21

HPE 480GB SATA 6G Read Intensive SFF (2.5in) SC 3yr Wty Digitally Signed Firmware SSD 868818-B21  
**NOTE: This drive will ship in Q1 2017.**

HPE 480GB SATA 6G Read Intensive SFF (2.5in) SC 3yr Wty SSD 872855-B21

HPE 480GB 6G SATA Read Intensive-2 SFF 2.5-in SC 3yr Wty Solid State Drive 804593-B21

HPE 240GB SATA 6G Read Intensive SFF (2.5in) SC 3yr Wty SSD 872853-B21

HPE 240GB 6G SATA Read Intensive-2 SFF 2.5-in SC 3yr Wty Solid State Drive 804587-B21

HPE 120GB 6G SATA Read Intensive-2 SFF 2.5-in SC 3yr Wty Solid State Drive 804581-B21

HPE 80GB 6G SATA Read Intensive-2 SFF 2.5-in SC 3yr Wty Solid State Drive 804575-B21

### 6G SATA Hot Plug SFF (2.5-inch) SC Write Intensive Solid State Drives

HPE 1.2TB 6G SATA Write Intensive-2 SFF 2.5-in SC 3yr Wty Solid State Drive 804677-B21

## Core Options

HPE 800GB 6G SATA Write Intensive-2 SFF 2.5-in SC 3yr Wty Solid State Drive	804671-B21
HPE 400GB 6G SATA Write Intensive-2 SFF 2.5-in SC 3yr Wty Solid State Drive	804665-B21
HPE 200GB 6G SATA Write Intensive-2 SFF 2.5-in SC 3yr Wty Solid State Drive	804639-B21

### 6G SATA Hot Plug SFF (2.5-inch) SC Mixed Use Solid State Drives

HPE 1.92TB 6G SATA Mixed Use-3 SFF 2.5-in SC 3yr Wty Solid State Drive	817011-B21
HPE 1.6TB 6G SATA Mixed Use-2 SFF 2.5-in SC 3yr Wty Solid State Drive	804631-B21
HPE 960GB 6G SATA Mixed Use-3 SFF 2.5-in SC 3yr Wty Solid State Drive	816995-B21
HPE 800GB 6G SATA Mixed Use-2 SFF 2.5-in SC 3yr Wty Solid State Drive	804625-B21
HPE 480GB 6G SATA Mixed Use-2 SFF 2.5-in SC 3yr Wty Solid State Drive	832414-B21
HPE 480GB 6G SATA Mixed Use-3 SFF 2.5-in SC 3yr Wty Solid State Drive	816985-B21
HPE 200GB 6G SATA Mixed Use-2 SFF 2.5-in SC 3yr Wty Solid State Drive	804613-B21

### 6G SATA Hot Plug LFF (3.5-inch) LP Write Intensive Solid State Drives

HPE 800GB 6G SATA Write Intensive-2 LFF 3.5-in LPC 3yr Wty Solid State Drive	831725-B21
--	------------

### 6G SAS (2.5-inch) 512e SC HDD

HPE 1TB 12G SAS 7.2K rpm SFF (2.5-inch) SC 512e 1yr Warranty Hard Drive	765464-B21
HPE 2TB 12G SAS 7.2K rpm SFF (2.5-inch) SC 512e 1yr Warranty Hard Drive	765466-B21

### 6G SATA (2.5-inch) 512e SC HDD

HPE 1TB 6G SATA 7.2K rpm SFF (2.5-inch) SC 512e 1yr Warranty Hard Drive	765453-B21
HPE 2TB 6G SATA 7.2K rpm SFF (2.5-inch) SC 512e 1yr Warranty Hard Drive	765455-B21

### M.2 Solid State Drives

HPE Dual 120GB Value Endurance Solid State M.2 Enablement Kit	777894-B21
HPE 120GB Value Endurance Solid State M.2 Enablement Kit	788028-B21

**NOTE:** M.2 go in PCIe slots and B140i SATA Controller only

### Hard Drive Blank Kits

HPE Large Form Factor Hard Drive Blank Kit	807878-B21
HPE Small Form Factor Hard Drive Blank Kit	666987-B21

## HPE Networking

### 1 Gigabit Ethernet adapters

HPE Ethernet 1Gb 4-port 331T Adapter	647594-B21
HPE Ethernet 1Gb 2-port 332T Adapter	615732-B21

### 10 Gigabit Ethernet adapters

HP Ethernet 10Gb 2-port 530SFP Adapter	652503-B21
HPE Ethernet 10Gb 2-port 530T Adapter	656596-B21
HPE Ethernet 10G 2-port 546SFP+ Adapter	779793-B21
HPE Ethernet 10Gb 2-port 560SFP+ Adapter	665249-B21
HPE Ethernet 10Gb 2-port 561T Adapter	716591-B21
HPE Ethernet 10Gb 2-port 562SFP+ Adapter	727055-B21

### 25 Gigabit Ethernet adapters

HPE Ethernet 4x25Gb 1-port 620QSFP28 Adapter	817762-B21
HPE Ethernet 10/25Gb 2-port 640SFP28 Adapter	817753-B21

**NOTE:** The HPE Apollo 4200 Gen9 chassis ships with 2x1Gb Embedded.



## Core Options

**NOTE:** A minimum of two Gigabytes (2 GB) of server memory is required per each adapter.  
**NOTE:** Direct Attach Cable (DAC) for copper environments or fiber transceivers and cables for fiber-optic environments must be purchased separately. Please see the related NIC QuickSpecs for Technical Specifications and additional information:

<http://www.hpe.com/go/ProLiantNICs>

### FlexibleLOM Adapters

HPE Ethernet 1Gb 4-port 366FLR Adapter	665240-B21
HP FlexFabric 10Gb 2-port 533FLR-T Adapter	700759-B21
HP FlexFabric 10Gb 2-port 534FLR-SFP+ Adapter	700751-B21
HPE Ethernet 10Gb 2P 546FLR-SFP+ Adapter	779799-B21
HPE Ethernet 10Gb 2-port 560FLR-SFP+ Adapter	665243-B21
HPE Ethernet 10Gb 2-port 562FLR-SFP+ Adapter	727054-B21
HPE Ethernet 10/25Gb 2-port 640FLR-SFP28 Adapter	817749-B21
HPE FlexFabric 10Gb 4-port 536FLR-T Adapter	764302-B21

### HPE InfiniBand

HPE InfiniBand FDR 2-port 545QSFP Adapter	702211-B21
<b>NOTE:</b> The RHEL6.5 driver is not part of SPP, but may be downloaded here: <a href="http://downloads.linux.hp.com/SDR/downloads/MLNX_OFED/">http://downloads.linux.hp.com/SDR/downloads/MLNX_OFED/</a>	
HPE InfiniBand FDR/Ethernet 10Gb/40Gb 2-port 544+QSFP Adapter	764284-B21
HPE InfiniBand FDR/Ethernet 10Gb/40Gb 2-port 544+FLR-QSFP Adapter	764285-B21
HPE InfiniBand QDR/Ethernet 10Gb 2-port 544+FLR-QSFP Adapter	764286-B21
QLogic InfiniBand 4X QDR PCI-E G2 Dual Port HCA	583211-B21
HPE 100Gb 1-port OP101 QSFP28 x16 PCIe Gen3 with Intel Omni-Path Architecture Adapter	829335-B21
HPE 100Gb 1-port OP101 QSFP28 x8 PCIe Gen3 with Intel® Omni-Path Architecture Adapter	829334-B21
HPE InfiniBand EDR/Ethernet 100Gb 1-port 840QSFP28 Adapter	825110-B21
HPE InfiniBand EDR/Ethernet 100Gb 2-port 840QSFP28 Adapter	825111-B21

### HPE I/O Expansion Options

HPE Apollo 4200 Gen9 2SFF and 2FHHL Kit	806564-B21
<b>NOTE:</b> This riser kit allows for two additional small form factor drives in the rear and two PCIe slots 3-4 are available by using slot 2 as a standup expansion slot <b>NOTE:</b> Using the above kit, PCIe slot 3 and 4 may be populated. <b>NOTE:</b> Slot3: 1x Gen3 x8 FH/FL. Slot 4: 1xGen3 x8 FH/HL.	

### HPE Power Supplies 1 Gigabit Ethernet adapters

HPE 800W Flex Slot Titanium Hot Plug Power Supply Kit	720482-B21
HPE 800W Flex Slot Universal Hot Plug Power Supply Kit	720484-B21
HPE 800W Flex Slot Platinum Hot Plug Power Supply Kit	720479-B21
HPE 800W Flex Slot -48VDC Hot Plug Power Supply Kit	720480-B21
HPE 1400W Flex Slot Platinum Plus Hot Plug Power Supply Kit	720620-B21

**NOTE:** All power supplies must be of the same input voltage, output rating, and efficiency rating. If non-matching power supplies are installed, you may receive an error message and/or experience operational issues with your server.

## Core Options

**NOTE:** Prior to selecting a power supply option, it is highly recommended that you review your server configuration in the HPE Power Advisor tool to determine the right size power supply for your server configuration. The HPE Power Advisor is located at: <http://www.hp.com/go/hppoweradvisor>

**NOTE:** The above power supply options are all 80Plus Platinum-certified with an efficiency rating of up to 94%. Support for HPE Power Discovery Services is included with the 1400W Flex Slot option. Power specifications and technical content for all HPE Server power supplies can be found at <http://www.hpe.com/go/proliant/powersupply>

**NOTE:** Maximum of 2 Flex Slot PS per platform.

### HPE Cooling Options

HP Apollo 4200 Gen9 Redundant Fan Kit

806562-B21

NOTE:NOTE: The Apollo 4200 Redundant Fan Kit allows the server to reach up to 8 fans using a 1 processor configuration, or 10 total fans using a 2 processors configuration.

## Additional Options

**NOTE:** Some options may not be integrated at the factory. To ensure only valid configurations are ordered, Hewlett Packard Enterprise recommends the use of a Hewlett Packard Enterprise approved configurator. Contact your local sales representative for additional information.

### HPE Insight Software HPE Insight Control

HPE Insight Control including 1yr 24x7 Technical Support and Updates Single Server License C6N27A

HPE Insight Control including 1yr 24x7 Technical Support and Updates Electronic License C6N28ABE

HPE Insight Control Server Provisioning Media Kit BD883A

HPE Insight Management Media Kit C6N31A

**NOTE:** Electronic and Flexible-Quantity licenses can be used to purchase multiple licenses with a single activation key.

**NOTE:** Customer will receive a license entitlement certificate. The license entitlement certificate must be redeemed online or via fax in order to obtain the license activation key(s). Includes one year of 24 x 7 HPE Software Technical Support and Update Service.

**NOTE:** Licenses ship without media. The HPE Insight Control Media Kit can be ordered separately, or can be downloaded at: <http://www.hpe.com/go/insightupdates>

**NOTE:** For additional license options please see the QuickSpecs at:

[http://h18000.www1.hpe.com/products/QuickSpecs/12631\\_div/12631\\_div.html](http://h18000.www1.hpe.com/products/QuickSpecs/12631_div/12631_div.html)

### Embedded Management

#### HPE iLO Advanced

HPE iLO Advanced including 1yr 24x7 Technical Support and Updates Single Server License 512485-B21

HPE iLO Advanced 1 Server License with 3yr 24x7 Tech Support and Updates BD505A

HPE iLO Advanced including 1yr 24x7 Technical Support and Updates E-LTU E6U59ABE

HPE iLO Advanced including 3yr 24x7 Technical Support and Updates E-LTU E6U64ABE

### High Performance Clusters

#### HPE Cluster Management Utility

HPE Insight Cluster Management Utility 1yr 24x7 Flexible License QL803B

HPE Insight Cluster Management Utility 3yr 24x7 Flexible License BD476A

**NOTE:** These part numbers can be used to purchase one certificate for multiple licenses and support with a single activation key. Each license is for one node (server). Customer will receive a printed end user license agreement and license entitlement certificate via physical shipment. The license entitlement certificate must be redeemed online in order to obtain a license key. Customer also will receive a support agreement.

HPE Insight Cluster Management Utility Media BD477A

**NOTE:** For additional license kits please see the QuickSpecs at:

<http://www8.hp.com/h20195/v2/GetDocument.aspx?docname=c04111735>

### HPE PCIe Workload Accelerator Options

#### NVME PCIe Workload Accelerators

HPE 2.0TB NVMe Mixed Use HH/HL PCIe Workload Accelerator 803204-B21

HPE 1.6TB NVMe Write Intensive HH/HL PCIe Workload Accelerator 803197-B21

HPE 1.6TB NVMe Mixed Use HH/HL PCIe Workload Accelerator 803202-B21

HPE 800GB NVMe Write Intensive HH/HL PCIe Workload Accelerator 803195-B21

HPE 800GB NVMe Mixed Use HH/HL PCIe Workload Accelerator 803200-B21

### HPE Security

HPE 2U Security Bezel Kit 666988-B21

## Additional Options

HPE Trusted Platform Module 2.0 Kit 745823-B21

**NOTE:** If the TPM Module (488069-B21) is installed, then there is no support for TPM 2.0  
**NOTE:** This is supported on both the E5-2600v3 and E5-2600v4 processors

**HPE 2U Security  
 Bezel Kit  
 666988-B21**

**HPE Trusted  
 Platform Module 2.0  
 Kit  
 745823-B21**

**NOTE:NOTE: If the  
 TPM Module  
 (488069-B21) is  
 installed, then there  
 is no support for  
 TPM 2.0**

HPE Trusted Platform Module Option 488069-B21

**NOTE:NOTE: This is  
 supported on both  
 the E5-2600v3 and  
 E5-2600v4  
 processors**

**HPE Trusted  
 Platform Module  
 Option  
 488069-B21**

**HPE Storage  
 Controllers**

### SAS Controllers

#### HPE Smart Array Controllers

HPE Smart Array P440/4GB FBWC 12Gb 1-port Int SAS Controller 726821-B21

**NOTE:** Provides support for the SAS/SATA drives in the 2<sup>nd</sup> HDD cage and its expander or rear SAS/SATA drives in the rear HDD cage.

**NOTE:** HPE P440 Smart Array Controller is only supported in PCIe slot 1.

HPE Smart Array P441/4G Controller 726825-B21

HPE Smart Array P841/4G Controller 726903-B21

**NOTE:** HPE P841 Smart Array Controller is only supported in PCIe slot 3 or PCIe slot 4. To utilize these slots, a 2 SFF and 2 FHHL Kit (P/N: 806564-B21) is required.

#### HPE Smart Host Bus Adapters

HPE H240 12Gb 2-ports Int Smart Host Bus Adapter 726907-B21

**NOTE:** Provides support for the rear SAS/SATA drives in the rear HDD cage only.

## Additional Options

**NOTE:** HPE Apollo 4200 Gen9 Smart HBA H240 FIO Rear Cable Kit (838823-B21) and HPE SAS Smart HBA H240 FIO Controller Mode for Rear Storage(838827-B21) are required when HPE H240 12Gb 2-ports Int Smart Host Bus Adapter (726907-B21) is selected.

HPE H241 12Gb 2-ports Ext Smart Host Bus Adapter 726911-B21

### Optional Software

HPE Secure Encryption No Media Flexible License per Drive D8S84A

HPE Secure Encryption No Media E-LTU per Drive D8S85AAE

**NOTE:** HPE Secure Encryption is supported when one of the supported Smart Array Controllers or the supported Smart SAS HBA (configured in the RAID mode) is installed in the server. HPE Secure Encryption licensing is based on the number of physical drives requiring encryption

**NOTE:** For more information about HPE Secure Encryption, go to <http://www.hpe.com/go/hpsecureencryption>

HPE 32GBmicroSDMainstream Flash Media Kit

### HPE USB and SD Options

#### HPE USB Keyboard and Mouse

HPE USB BFR with PVC Free US Keyboard/Mouse Kit

**NOTE:** Please see the [HPE USB Keyboard and Mouse QuickSpecs](#) for information on additional options and product specifications. 631341-B21

### Rail Kits

**NOTE:** Rail kits are optional for the HPE Apollo 4200 Gen9 CTO Chassis and are no longer included standard with the server. Customers have the option to purchase their server without a rail kit.

**CAUTION:** Hewlett Packard Enterprise recommends that a minimum of two people are required for all Rack Server installations. Please refer to your installation instructions for proper tools and number of people to use for any installation.

HPE 2U Shelf-Mount Adjustable Rail Kit 822731-B21

### HPE USB and SD Options

#### HPE Enterprise Mainstream Flash Media Kits for Memory Cards

HPE 32GB microSD Enterprise Mainstream Flash Media Kit 700139-B21

HPE 8GB microSD Enterprise Mainstream Flash Media Kit 726116-B21

HPE 8GB USB Enterprise Mainstream Flash Media Drive Key Kit 737953-B21

HPE Dual 8GB microSD EM USB Kit 741279-B21

**HPE Storage Options** **NOTE:** For the complete listing of Fibre Channel Host Bus Adapters for Windows 2000, Windows Server 2003 and Linux, please see:

<http://h18006.www1.hp.com/storage/saninfrastructure/hba.html>

#### Emulex Fibre Channel HBAs

HPE 81E 8Gb 1-port PCIe Fibre Channel Host Bus Adapter AJ762B

HPE 82E 8Gb 2-port PCIe Fibre Channel Host Bus Adapter AJ763B

HPE StoreFabric SN1100E 16Gb Single Port Fibre Channel Host Bus Adapter C8R38A

HPE StoreFabric SN1100E 16Gb Dual Port Fibre Channel Host Bus Adapter C8R39A

#### QLogic Fibre Channel HBAs

HPE 81Q 8Gb 1-port PCIe Fibre Channel Host Bus Adapter AK344A

HPE 82Q 8Gb 2-port PCIe Fibre Channel Host Bus Adapter AJ764A

HPE StoreFabric SN1000Q 16GB 1-port PCIe Fibre Channel Host Bus Adapter QW971A

## Additional Options

HPE StoreFabric SN1000Q 16GB 2-port PCIe Fibre Channel Host Bus Adapter	QW972A
<b>Converged Network Adapter</b>	
HPE StoreFabric CN1100R Dual Port Converged Network Adapter	QW990A
HPE StoreFabric CN1100R 10GBASE-T Dual Port Converged Network Adapter	N3U52A
HPE 3 year Foundation Care Next business day Apollo 4200 Service	U8MG4E
HPE 3 year Foundation Care Next business day with DMR Apollo 4200 Service	U8MG5E
HPE 3 year Foundation Care Next business day with CDMR Apollo 4200 Service	U8MG6E
HPE 3 year Foundation Care 24x7 Apollo 4200 Service	U8MH3E
HPE 3 year Foundation Care 24x7 wDMR Apollo 4200 Service	U8MH4E
HPE 3 year Foundation Care 24x7 wCDMR Apollo 4200 Service	U8MH5E
HPE 3 year Proactive Care 24x7 Apollo 4200 Service	U8MH6E
HPE 3 year Proactive Care 24x7 with DMR Apollo 4200 Service	U8MH7E
HPE 3 year Proactive Care 24x7 with CDMR Apollo 4200 Service	U8MH8E
HPE Installation ProLiant DL1000/DL2000 Service	UM857E
HPE Installation and Startup DL1000/DL2000 Service	UM858E

## Memory

### Memory Subsystem Architecture

Each Intel® Xeon® E5-2600v3 or E5-2600v4 family processor socket contains four memory channels per installed processor with two DIMMs per channel for a total of eight (8) DIMMs or a grand total of sixteen (16) DIMMs for the server.

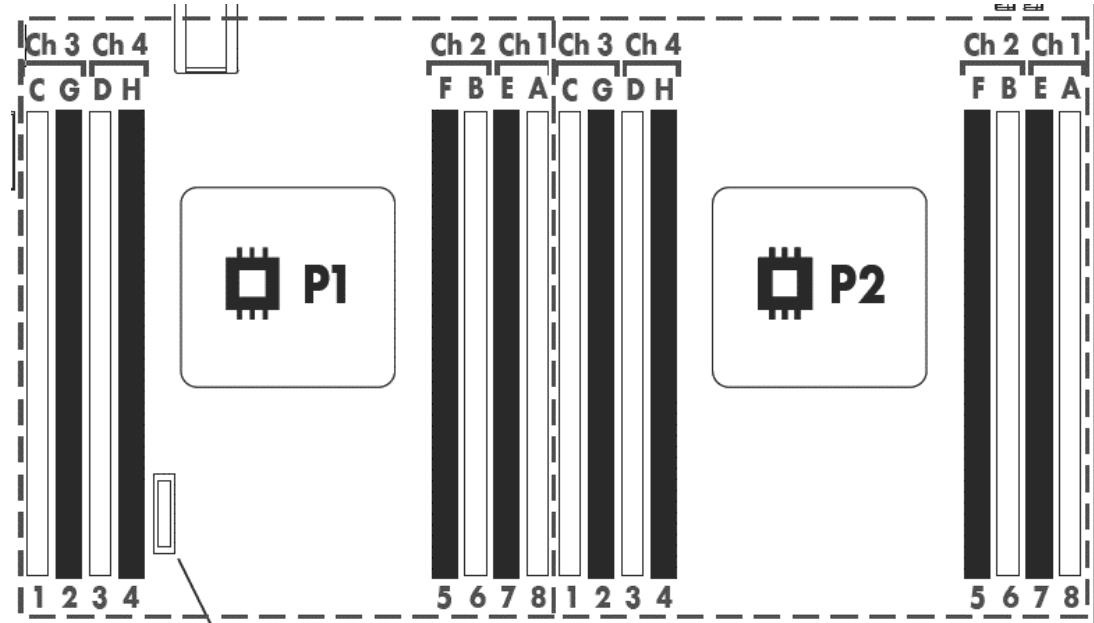

### Memory Population Guidelines

#### DIMM Configuration

**NOTE:** This information is for Advanced ECC memory mode. If operating in other modes, see the user guide Key.

#### Alpha- population order

Numeric-DIMM Slot ID for spare replacement

Before Installing DIMMs, review the following population guidelines:

- Install DIMMs only if the corresponding processor is installed.
- When two processors are installed, balance the total capacity of the DIMM's across the two processors.
- White DIMM's slots denote the first slot of a channel (Ch 1-A, Ch 2-B, Ch 3-C, Ch 4-D).
- Do not mix RDIMMs and LRDIMMs in the same system.

When only one processor is installed, install DIMMs in sequential alphabetic order; A, B, C, D, E, F, and so forth.

When two processors are installed, install DIMMs in sequential alphabetic order; P1-A, P2-A, P1-B, P2-B, P1-C, P2-C, and so forth.

For DIMM spare replacement, install the DIMMs per slot numbers as instructed by your system software. These are general DIMM population rules. For specific memory mode population rules see the server user guide on the Hewlett Packard Enterprise website.

<http://www.hp.com/support/Apollo4200Gen9/docs>.

#### General Memory Population Rules and Guidelines:

- White DIMM slots denote the first slot of a channel. For 1 DPC (DIMM per channel) populate white slots only.  
A minimum of one DIMM is required per server.
- Install DIMMs only if the corresponding processor is installed.
- If only one processor is installed in a two processor system, only half of the DIMM slots are available.
- To maximize performance, it is recommended to balance the total memory capacity between all installed processors and to load the channels similarly whenever possible.
- When two processors are installed, balance the DIMMs across the two processors.

## Memory

- Populate DIMMs from heaviest load (quad-rank) to lightest load (single-rank) within a channel. Heaviest load
- (DIMM with most ranks) within a channel goes furthest from the processor.
- Do not mix RDIMMs or LRDIMMs.
- LRDIMMs are supported up to 2 DIMMs per channel.
- DIMMs of different speeds may be mixed in any order; the server will select a common optimal speed.
- The maximum memory speed is a function of the memory type, memory configuration, and processor model.
- The maximum memory capacity is a function of the memory type and number of installed processors.
- HPE memory from previous generation servers is not compatible with the HPE Apollo 4200 Gen9 Server. Certain HPE SmartMemory features such as memory authentication and enhanced performance may not be supported.
- To realize the performance memory capabilities listed in this document, HPE SmartMemory is required. For additional information, please see the HPE SmartMemory QuickSpecs at: [http://h18000.www1.hpe.com/products/QuickSpecs/14225\\_div/14225\\_div.html](http://h18000.www1.hpe.com/products/QuickSpecs/14225_div/14225_div.html)  
For memory population rules and additional memory guidelines, please see the HPE Apollo 4200 Gen9 user guide at <http://www.hpe.com/support>
- There are four (4) Memory channels per processor; eight (8) channels per 2 processor server.
- There are two (2) DIMM slots for each memory channel; sixteen (16) total slots for 2 processor server.
- Memory channels 1 and 3 consists of the two (2) DIMMs that are furthest from the processor.
- Memory channel 2 and 4 consists of the two (2) DIMMs that are closest to the processor.

### Intel Gen9 Supported Memory Bandwidth for HPE ProLiant Gen9 Intel® Xeon®E5-2600v3 Series Processor Family

DIMM Type	Registered DIMMs (RDIMMs)					Load Reduced (LRDIMMs)		
	Single Rank (1R)		Dual Rank (2R)			Dual Rank (2R)	Quad Rank (4R)	
DIMM Rank								
DIMM Capacity	4GB	8GB	8GB	16GB	32GB	16GB	32GB	64GB
DIMM Native Speed (MHz)	2133							
<b>Voltage</b>	Std Voltage 1.2V							
<b>SLOTS THAT CAN BE POPULATED</b>								
16 slot server nodes	16	16	16	16	16	16	16	16
<b>MAXIMUM CAPACITY (GB)*</b>	64	128	128	256	512	256	512	1026

### Intel Gen9 Supported Memory Bandwidth for HPE ProLiant Gen9 Intel® Xeon®E5-2600v4 Series Processor Family

DIMM Type	Registered DIMMs (RDIMMs)				Load Reduced (LRDIMMs)	
	Single Rank (1R)		Dual Rank (2R)		Dual Rank (2R)	Quad Rank (4R)
DIMM Rank						
DIMM Capacity	8GB	16GB	16GB	32GB	32GB	64GB
DIMM Native Speed (MHz)	2400					
<b>Voltage</b>	Std Voltage 1.2V					
<b>SLOTS THAT CAN BE POPULATED</b>						
16 slot server nodes	16	16	16	16	16	16
<b>MAXIMUM CAPACITY (GB)*</b>	128	256	256	512	512	1024



Memory

Memory Speed by Processor Model	Processor Models		Supported Memory Speeds	
	E5-2603v3, E5-2609v3,		1600MHz	
	E5-2620v3, E5-2623v3, E5-2630v3, E5-2630Lv3, E5-2640v3,		1866MHz	
	E5-2637v3, E5-2643v3, E5-2650v3, E5-2650Lv3, E5-2660v3, E5-2667v3, E5-2670v3, E5-2680v3, E5-2683v3, E5-2690v3, E5-2695v3, E5-2697v3, E5-2698v3, E5-2699v3,		2133MHz	
	E5-2603v4, E5-2609v4,		1866MHz	
	E5-2620v4, E5-2623v4, E5-2630v4, E5-2630Lv4, E5-2640v4		2133MHz	
	E5-2637v4, E5-2643v4, E5-2650v4, E5-2650Lv4, E5-2660v4, E5-2667v4, E5-2680v4, E5-2683v4, E5-2690v4, E5-2695v4, E5-2697v4, E5-2697Av4, E5-2698v4, E5-2699v4		2400MHz	
Standard and Maximum Memory Capacity (Pre-configured Models)	Pre-Configured Models	Standard Memory	Maximum Memory Plus Optional Memory	Standard Memory Replaced with Optional Memory
	SFF Model	16GB (1x16GB)	496GB (15x32GB, 1x16GB)	1024GB (16x64GB)
	LFF Model	16GB (1x16GB)	496GB (15x32GB, 1x16GB)	1024GB (16x64GB)

DDR4 memory options part number decoder

**NOTE:** Capacity references are rounded to the common gigabyte (GB) values.

- 2GB = 2,048MB
- 4GB = 4,096MB
- 8GB = 8,192MB
- 16GB = 16,384MB
- 32GB = 32,768MB
- 64GB = 65,536MB

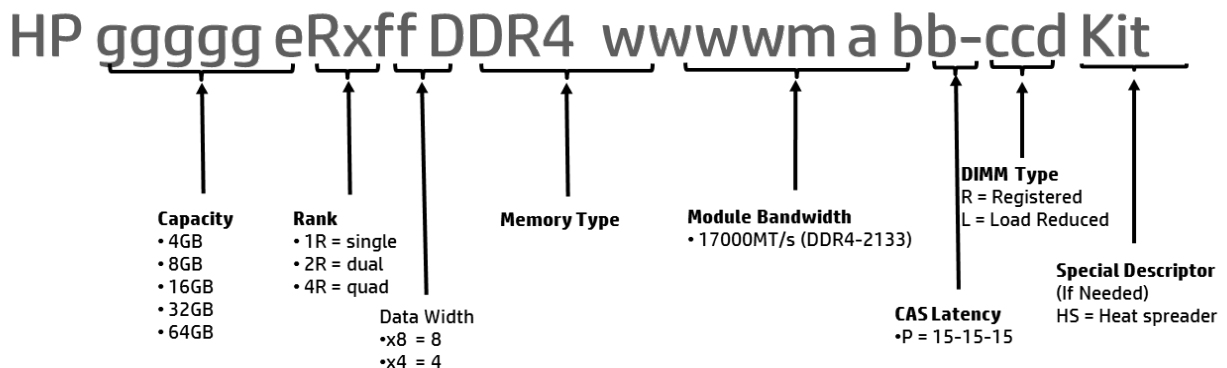

## Technical Specifications

<b>System Unit</b>	<b>Dimensions</b> (L x W x D)	3.44 x 17.63 x 32 in (8.75cm x 44.8 x 81.28 cm) <b>NOTE: Dimensions without Bezel.</b>		
	<b>Weight</b> (approximate)	Minimum: (Minimum – 24LFF chassis)	51.04 lb (23.2 kg)	
		Maximum: (Maximum - 24LFF chassis)	89.32 lb (40.6 kg)	
		Minimum: (Minimum – 48SFF chassis)	46.64 lb (21.2 kg)	
		Maximum: (Maximum – 48SFF chassis)	77lb (35kg)	
	<b>Input Requirements</b> (per power supply)	Range Line Voltage	100 to 120 VAC 200 to 240 VAC	
		<b>BTU Rating</b>	Maximum	For 800W Power Supply: 3207 BTU/hr (at 100 VAC), 3071 BTU/hr (at 200 VAC), 3112 BTU/hr (at 240 VAC) for China Only
	<b>Power Supply Output</b> (per power supply)	Rated Steady-State Power	For 1400W Power Supply: 1400W (at 240 VAC), 1400W (at 240 VAC) For 800W Power Supply: 800W (at 100 VAC), 800W (at 240 VAC), 800W (at 240 VAC) input for China only	
		Maximum Peak Power	For 1400W Power Supply: 1400W (at 200 to 240 1VAC), 1400W (at 240 VAC) input for China only For 800W Power Supply: 800W (at 100 to 127 VAC), 800W (at 200 to 240 1VAC), 800W (at 240 VAC) input for China only	
	<b>System Inlet Temperature</b>	Standard Operating Support	10° to 35°C (50° to 95°F) at sea level with an altitude derating of 1.0°C per every 305 m (1.8°F per every 1000 ft) above sea level to a maximum of 3050 m (10,000 ft), no direct sustained sunlight. Maximum rate of change is 20°C/hr (36°F/hr). The upper limit and rate of change may be limited by the type and number of options installed. System performance during standard operating support may be reduced if operating with a fan fault or above 30°C (86°F).	
<b>Extended Ambient Operating Support</b>		For approved hardware configurations, the supported system inlet range is extended to be: 5° to 10°C (41° to 50°F) and 35° to 40°C (95° to 104°F) at sea level with an altitude derating of 1.0°C per every 175 m (1.8°F per every 574 ft) above 900 m (2953 ft) to a maximum of 3050 m (10,000 ft). The approved hardware configurations for this system are listed at the URL: <a href="http://www.hp.com/servers/Ashrae">http://www.hp.com/servers/Ashrae</a> System performance may be reduced if operating in the extended ambient operating range or with a fan fault.		
Non-operating		-30° to 60°C (-22° to 140°F). Maximum rate of change is 20°C/hr (36°F/hr).		

## Technical Specifications

<b>Relative Humidity</b>	Operating	Minimum to be the higher (more moisture) of -12°C (10.4°F) dew point or 8% relative humidity. Maximum to be the lower (less moisture) of 24°C (75.2°F) dew point or 90% relative humidity.
(non-condensing)	Non-operating	5 to 95% relative humidity (Rh), 38.7°C (101.7°F) maximum wet bulb temperature, non-condensing.
<b>Altitude</b>	<b>Operating</b>	3048 m (10,000 ft). This value may be limited by the type and number of options installed. Maximum allowable altitude change rate is 457 m/min (1500 ft/min).
	<b>Non-operating</b>	9144 m (30,000 ft). Maximum allowable altitude change rate is 457 m/min (1500 ft/min).
<b>Acoustic Noise</b>	Listed are the declared A-Weighted sound power levels (LWAd) and declared average bystander position A-Weighted sound pressure levels (LpAm) when the product is operating in a 23°C ambient environment. Noise emissions were measured in accordance with ISO 7779 (ECMA 74) and declared in accordance with ISO 9296 (ECMA 109).	
	<b>Idle</b>	
L WAd	4.5 B Entry LFF	
	4.3 B Entry SFF	
	4.8 B Typical LFF	
	4.8 B Typical SFF	
	4.8 B Performance LFF	
L pAm	4.9 B Performance SFF	
	29 dBA Entry LFF	
	26 dBA Entry SFF	
	32 dBA Typical LFF	
	33 dBA Typical SFF	
	33 dBA Performance LFF	
	34 dBA Performance SFF	
	<b>Operating</b>	
L WAd	4.5 B Entry LFF	
	4.3 B Entry SFF	
	4.8 B Typical LFF	
	4.9 B Typical SFF	
	4.9 B Performance LFF	
L pAm	5.4 B Performance SFF	
	30 dBA Entry LFF	
	27 dBA Entry SFF	
	33 dBA Typical LFF	
	33 dBA Typical SFF	
	35 dBA Performance LFF	
	37 dBA Performance SFF	

**NOTE:** Entry LFF Configuration tested included one Intel E5-2620v4 processor, two 3TB LFF SAS HDD at front drive cage, one 3TB LFF SATA HDD at rear drive cage, one 16GB DDR4 RDIMMs 2400MHz, four system fans, one 1400W power supply, one P840ar Flexible Smart Array Controller, one Flexible Storage 96W battery

**NOTE:** Entry SFF configuration tested included one Intel E5-2620v4 processor, two 300GB SFF SAS HDD at front drive cage, one 16GB DDR4 RDIMMs 2400MHz, four system fans, one 1400W power supply, one P840ar Flexible Smart Array Controller, one Flexible Storage 96W battery.

**NOTE:** Typical LFF configuration tested included one Intel E5-2620v4 processor, twelve 3TB LFF SAS HDD at front drive cage, one 3TB LFF SATA HDD at rear drive

## Technical Specifications

cage, four 16GB DDR4 RDIMMs 2400MHz, four system fans, one 1400W power supply, one P840ar Flexible Smart Array Controller, one Flexible Storage 96W Battery.

**NOTE:** Typical SFF configuration tested included one Intel E5-2620v4 processor, twenty-four 300GB SFF SAS HDD at front drive cage, four 16GB DDR4 RDIMMs 2400MHz, four system fans, one 1400W power supply, one P840ar Flexible Smart Array Controller, one Flexible Storage 96W Battery.

**NOTE:** Performance LFF configuration tested included two Intel E5-2620v4 processor, sixteen 3TB LFF SAS HDD at front drive cages, one 3TB LFF SATA HDD at rear drive cage, eight 16GB DDR4 RDIMMs 2400MHz, five system fans, two 1400W power supplies, one P840ar Flexible Smart Array Controller, one Flexible Storage 96W battery.

**NOTE:** Performance SFF configuration tested included two Intel E5-2620v4 processor, thirty-two 300GB SFF SAS HDD at front drive cages, eight 16GB DDR4 RDIMMs 2400MHz, five system fans, two 1400W power supplies, one P840ar Flexible Smart Array Controller, one Flexible Storage 96W Battery.

**NOTE:** Values are subject to change without notification and are for reference only.

**NOTE:** Performance of system, options, and ancillary equipment will vary depending on the system configurations

**NOTE:** Levels presented do not account for non-Hewlett Packard Enterprise installed hardware.

<b>Emissions Classification</b> (EMC)	<b>FCC Rating</b>	Class A
	<b>Normative Standards</b>	CISPR 22; EN55022; EN55024; FCC CFR 47, Pt 15; ICES-003; CNS13438; GB9254; K22;K24; EN 61000-3-2; EN 61000-3-3; EN 60950-1; IEC 60950-1 <b>NOTE:</b> Product conformance to cited product specifications is based on sample (type) testing, evaluation, or assessment. This product or family of products is eligible to bear the appropriate compliance logos and statements.
<b>HPE Dynamic Smart Array B140i Controller</b>	<b>Number of PCI links</b>	Four (4)
	<b>PCI link rate</b>	4GB/s
	<b>Storage protocol support</b>	SATA
	<b>SAS/SATA peak data transfer rate</b>	6Gb/s
	<b>Number of SAS/SATA links</b>	6 links
	<b>SAS/SATA connectivity</b>	1x4 connectors; 2x1 connectors
	<b>Expander support</b>	No
	<b>Drives supported (max)</b>	Up to 6 Internal Drives
	<b>RAID support</b>	0, 1, 10, 5 SATA
	<b>Software management</b>	HPE SSA, SMH, SIM
	<b>Warranty</b>	Server warranty
	<b>HPE Secure Encryption license</b>	Not Supported
	<b>HPE SmartCache License</b>	Not Supported

## Technical Specifications

	<b>HPE Smart Storage Administrator</b>	Supported
<b>HPE Ethernet 1Gb 2-port 361i Adapter</b>	<b>Network Interface</b>	10Base-T/100Base-TX/1000Base-TX
	<b>Compatibility</b>	IEEE 802.3 10Base-T IEEE 802.3ab 1000Base-T IEEE 802.3u 100Base-TX IEEE 1588, IEEE 802.1AS IEEE 802.3az - Energy Efficient Ethernet (EEE)
	<b>Data Transfer Method</b>	PCI Express v 2.0, 5.0 GT/s, two lanes (x2)
	<b>Controller</b>	Intel I350 Powerville
	<b>Network Transfer Rate</b>	10Base-T (Half-Duplex) 10 Mb/s per port, 40 Mb/s combined 10Base-T (Full-Duplex) 20 Mb/s per port, 80 Mb/s combined 100Base-TX (Half-Duplex) 100 Mb/s per port, 400 Mb/s combined 100Base-TX (Full-Duplex) 200 Mb/s per port, 800 Mb/s combined
	<b>Connector</b>	1000Base-TX (Half and Full-Duplex) 1000Mb/s per port, 4000 Mb/s combined Two RJ-45
	<b>Cable Support</b>	10 Base-T Categories 3, 4 or 5 UTP; up to 328 ft (100 m) 10/100/1000 Base-TX Category 5 or higher UTP; up to 328 ft (100 m)
<b>Environment-friendly Products and Approach</b>	<b>End-of-life Management and Recycling</b>	Hewlett Packard Enterprise offers end-of-life Hewlett Packard Enterprise product return, trade-in, and recycling programs in many geographic areas. For trade-in information, please go to: <a href="https://www.hpe.com/us/tradein">https://www.hpe.com/us/tradein</a> To recycle your product, please go to: <a href="https://www.hpe.com/us/tradein">https://www.hpe.com/us/tradein</a> or contact your nearest Hewlett Packard Enterprise sales office. Products returned to Hewlett Packard Enterprise will be recycled, recovered or disposed of in a responsible manner. The EU WEEE directive (2002/95/EC) requires manufacturers to provide treatment information for each product type for use by treatment facilities. This information (product disassembly instructions) is posted on the Hewlett Packard Enterprise web site at: <a href="https://www.hpe.com/us/tradein">https://www.hpe.com/us/tradein</a> These instructions may be used by recyclers and other WEEE treatment facilities as well as Hewlett Packard Enterprise OEM customers who integrate and re-sell Hewlett Packard Enterprise equipment.

## Summary of Changes

Date	Version History	Action	Description of Change
23-Oct-2017	Version 13	Changed	Care Pack naming and Service and Support- Parts and Materials updated.
13-Feb-2017	From version 11 to 12	Update	Update Core Options and add missing NIC Options
4-Nov-2016	From version 10 to 11	Update	Remove HDD SKUs drives
26-Sept-2016	From version 9 to 10	Updated	Update technical specifications and standard features
8-Jul-2016	From version 8 to 9	Changed	Change the broken link for the warranty section
6-Jun-2016	From version 7 to 8	Changed	Change images in the overall section and updates throughout the document
31-Mar-2016	From version 6 to 7	Updated	Update the following sections, technical specifications, configuration, features and remove obsolete SKUs
16-Feb-2016	From version 5 to 6	Updated	Update the SAS and the SATA drives, remove obsoletes.
1-Dec-2015	From version 4 to 5	Updated	Update Technical information and configurations section
9-Oct-2015	From version 3 to 4	Updated	Update Core Options and Standard Features sections.
21-Aug-2015	From version 2 to 3	Updated	Remove non supported items and add Care Packs info.
8-Jun-2015	From version 1 to 2	Updated	Update technical specifications and standard features
1-Jun-2015	Version 1	Created	Create QS for HPE Apollo 4200 Gen9 Server



Sign up for updates

© Copyright 2017 Hewlett Packard Enterprise Development LP. The information contained herein is subject to change without notice. The only warranties for Hewlett Packard Enterprise products and services are set forth in the express warranty statements accompanying such products and services. Nothing herein should be construed as constituting an additional warranty. Hewlett Packard Enterprise shall not be liable for technical or editorial errors or omissions contained herein.

Intel® and Xeon® are registered trademarks of Intel Corporation in the U.S. and other countries. Microsoft®, Windows®, and Windows Server® are U.S. registered trademarks of the Microsoft group of companies.

For hard drives, 1GB = 1 billion bytes. Actual formatted capacity is less

c04616497 - 15256 - North America - V13 - 23-October-2017

